

# Acylic Spa Models

EVO, LEGEND FAMILY, STORM RANGE, ES



INTERNATIONAL

OWNER'S MANUAL  
& LIMITED WARRANTY

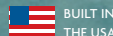

# MASTER SPAS OWNER'S MANUAL

---

## Welcome to the Ultimate in Relaxation!

Thank you for choosing your new spa built by Master Spas. For how-to videos and helpful tips on operating and maintaining your spa, please visit [www.masterspas.com/resources](http://www.masterspas.com/resources).

Please read the entire Owner's Manual before installing and using your spa. The goal of this manual is to provide you with safety and operational information plus some tips that will help you enjoy your spa to its fullest. At the time of print, this manual is accurate in its information. Master Spas reserves the right to change or improve its product without prior notice.

## REGISTER YOUR SPA

Please be sure to register your spa so we can efficiently assist with any questions you may have. Until your spa has been registered, Master Spas will not have record of your ownership. To register your spa, visit [www.masterspas.com/resources](http://www.masterspas.com/resources) and click on Spa Registration.

## SERIAL NUMBER LOCATION

The serial number for your spa is located near the filter area, on the spa system pack, or on the listing plate on the spa frame behind the front skirt panel. It is a seven digit number on most models or an "R" followed by 6 digits. For example, 2412345 or R241234.

## RECORD OF OWNERSHIP

Name \_\_\_\_\_

Address \_\_\_\_\_

City \_\_\_\_\_ State \_\_\_\_\_ Zip \_\_\_\_\_

Phone Number ( \_\_\_\_\_ ) \_\_\_\_\_ - \_\_\_\_\_ Date Purchased \_\_\_\_ / \_\_\_\_ / \_\_\_\_

Model \_\_\_\_\_ Serial # \_\_\_\_\_

Dealer Name \_\_\_\_\_

Service Tech Rep \_\_\_\_\_



**WATCH HOW-TO VIDEOS:**  
[masterspas.com/video-tutorials](http://masterspas.com/video-tutorials)



RELAX. IT'S

**Master Spas®**

6927 Lincoln Parkway  
Fort Wayne, IN 46804  
[masterspas.com](http://masterspas.com)

# TABLE OF CONTENTS

---

<b>Safety Instructions</b> .....	2-10
<b>Regulations</b> .....	11-13
<b>Compliance</b> .....	14
<b>VGB Suction Safety &amp; Maintenance Instructions</b> .....	15-16
<b>Glossary of Spa Terminology</b> .....	17-19
<b>The Advantages of EcoPur® Charge</b> .....	20-21
<b>Water Chemistry Terms You Should Know</b> .....	22-23
<b>Why Are Chemicals Important in a Spa</b> .....	24
<b>Water Maintenance</b> .....	25-28
Recommended Ranges.....	25
Start-Up.....	26
Schedule.....	27
Troubleshooting Guide .....	28
<b>Regular Maintenance Procedures</b> .....	29-36
<b>Spa Troubleshooting Guide</b> .....	37-38
<b>Winterizing &amp; Storing Your Spa</b> .....	39
<b>Model Specifications</b> .....	40
<b>Installation Instructions</b> .....	41-49
Site Preparation/General Guidelines.....	41-43
Electrical Requirements .....	44-47
Initial Spa Setup .....	48-49
<b>Operating Instructions</b> .....	50-88
Spa Controls - Icon Spa Touch.....	50-80
Spa Controls - Pump Diagrams.....	81-83
<b>Fusion Touch Sound System (if equipped)</b> .....	84-86
<b>Dream Lighting (if equipped)</b> .....	87
<b>Mast3rPur™ Option (if equipped)</b> .....	88-90
<b>International Acrylic Spa Models Limited Warranty</b> .....	91-94
<b>Spa Care &amp; Maintenance Record</b> .....	95-96

# SAVE THESE INSTRUCTIONS

Included with your new spa is a safety sign. The sign is for you and your guest's protection and is suitable for outdoor use in wet locations. The sign should be placed in a location visible to all users of the spa.

Please take time to point out the physical location of the safety sign and the importance of the safety precautions displayed on the safety sign to all of your guests. Remember, your safety and the safety of anyone who enjoys the use of your spa is our utmost concern.

The sign should be mounted with screws or another type of permanent fastener. Additional or replacement signs can be obtained from your dealer or direct from the factory.

## INTRODUCTION

It's time to relax! You now have your very own portable spa by Master Spas. By fully understanding the operation of each of the features of your new Master Spa, you will be assured of many years of hassle-free, hot water therapy and fun.

Your safety is of paramount importance to the Master Spas family. We urge you to carefully read, understand, and follow all information in this user manual before installing and using the spa. These warnings, instructions, and safety guidelines address some common risks of water recreation, but they cannot cover all risks and dangers in all cases. Always use caution, common sense, and good judgment when enjoying any water activity. Retain this information for future use.

Through reading and totally understanding the important information in your owner's manual, you will realize that you now own **THE ULTIMATE RELAXATION MACHINE!**<sup>®</sup>



Safety graphical symbol ISO 7010, M002 – Refer to instruction manual/booklet

**NO DIVING**

**DANGER: DIVING MAY  
RESULT IN SERIOUS  
INJURY OR DEATH.**



## **IMPORTANT SAFETY INSTRUCTIONS**

This spa is not intended for public/commercial use.

When installing and using this electrical equipment, basic safety precautions should be observed including the following:

### **READ AND FOLLOW ALL INSTRUCTIONS**

**WARNING** – To reduce the risk of injury, do not permit children to use this product unless they are closely supervised at all times.

A wire conductor is provided on this unit to connect a minimum 10AWG (5.26mm<sup>2</sup>) solid copper conductor between this unit and any metal equipment, metal enclosures of electrical equipment, metal water pipe, or conduit within 5 feet (1.5m) of the unit.

(For cord-connected/convertible units)

**DANGER** – Risk of injury.

- a) Replace damaged cord immediately.
- b) Do not bury cord.
- c) Connect to a grounded, grounding type receptacle only.

(For units intended for indoor use only)

**WARNING** – For indoor use only. This unit is not intended for outdoor use.

(For units intended for outdoor use only)

**WARNING** – For outdoor use only. This unit is not intended for indoor use.

**NO DIVING** **DANGER: DIVING MAY  
RESULT IN SERIOUS  
INJURY OR DEATH.**



## IMPORTANT SAFETY INSTRUCTIONS (CONT.)

(For units with GFCI)

**WARNING** – This product is provided with a ground-fault circuit interrupter located on the front panel of selected swim spas and on the power cord of 120 volt convertible spas. The GFCI must be tested before each use. With the product operating, open the service door. When the product stops operating, this merely indicates that the door is equipped with an electrical interlock. Next, push the test button on the GFCI and close the service door. The product should not operate. Now open the service door, push the reset button on the GFCI and close the service door. The product should now operate normally. When the product fails to operate in this manner, there is a ground current flowing indicating the possibility of an electric shock. Disconnect the power until the fault has been identified and corrected.

**DANGER** – Risk of Accidental Drowning. Extreme caution must be exercised to prevent unauthorized access by children. To avoid accidents, ensure that children cannot use this spa unless they are supervised at all times.

**DANGER** – Risk of Injury. The suction fittings in this spa are sized to match the specific water flow created by the pump. Should the need arise to replace the suction fittings or the pump, be sure that the flow rates are compatible. Never operate spa if the suction fittings are broken or missing. Never replace a suction fitting with one rated less than the flow rate marked on the original suction fitting.

**DANGER** – Risk of Electric Shock. Install at least 5 feet (1.5m) from all metal surfaces. As an alternative, a spa may be installed within 5 feet of metal surfaces if each metal surface is permanently connected by a minimum 10AWG (5.26mm<sup>2</sup>) solid copper conductor to the wire connector on the terminal box that is provided for this purpose. Be sure to review and comply with any overruling local or national applicable regulations.

**DANGER** – Risk of Electric Shock. Do not permit any electric appliance, such as a light, telephone, radio, or television, within 5 feet (1.5 m) of a spa.

**WARNING** – To reduce the risk of injury:

- a) The water in a spa should never exceed 104 °F (40 °C). Water temperatures between 100 °F (38 °C) and 104 °F (40 °C) are considered safe for a healthy adult. Lower water temperatures are recommended for young children and when spa use exceeds 10 minutes. Persons with any medical condition should seek medical advice before using a spa.

<b>NO DIVING</b>	<b>DANGER: DIVING MAY RESULT IN SERIOUS INJURY OR DEATH.</b>	
------------------	--	---

## IMPORTANT SAFETY INSTRUCTIONS (CONT.)

- b) Since excessive water temperatures have a high potential for causing fetal damage during the early months of pregnancy, pregnant or possibly pregnant women should limit spa water temperatures to 100°F (38°C) and duration of use and should also seek medical advice.
- c) Before entering a spa, the user should measure the water temperature with an accurate thermometer since the tolerance of water temperature-regulating devices varies.
- d) The use of alcohol, drugs, or medication before or during spa use may lead to unconsciousness with the possibility of drowning.
- e) Obese persons and persons with a history of heart disease, low or high blood pressure, circulatory system problems, or diabetes should consult a physician before using a spa.
- f) Persons using medication should consult a physician before using a spa since some medication may induce drowsiness while other medication may affect heart rate, blood pressure, and circulation.

(For spas with a gas heater)

**WARNING** – Risk of Suffocation. This spa is equipped with a gas heater and is intended for outdoor use only unless proper ventilation can be provided for an indoor installation.

## SAVE THESE INSTRUCTIONS

### **HYPERTHERMIA**

Hyperthermia occurs when the internal temperature of the body reaches a level several degrees above the normal body temperature of 98.6°F (37°C). Prolonged immersion in hot water may induce hyperthermia.

### **THE SYMPTOMS OF HYPERTHERMIA INCLUDE:**

- Dizziness • Fainting • Drowsiness • Lethargy
- Increase in Internal Body Temperature

### **THE EFFECTS OF HYPERTHERMIA INCLUDE:**

Unawareness of Impending Hazard • Failure to Perceive Heat • Failure to Recognize the Need to Exit Spa • Physical Inability to Exit Spa • Fetal Damage in Pregnant Women • Unconsciousness Resulting in a Danger of Drowning

**WARNING** – The use of alcohol, drugs, or medication can greatly increase the risk of hyperthermia.

<b>NO DIVING</b>	<b>DANGER: DIVING MAY RESULT IN SERIOUS INJURY OR DEATH.</b>	
------------------	--	---

## IMPORTANT SAFETY INSTRUCTIONS (CONT.)

**DANGER** – To reduce the risk of injury to persons, do not remove the suction grate. Suction through drains and skimmers is powerful when the jets in the spa are in use. Damaged covers can be hazardous to small children and adults with long hair. Should any part of the body be drawn into these fittings, turn off the spa immediately. As a precaution, long hair should not be allowed to float in the spa.



**EN 17125 – Do not put finger in massage jet**

**WARNING** – Install the spa so that water can be easily drained out of the compartment containing electrical components so as not to damage equipment. When installing the spa make sure to allow for an adequate drainage system to deal with any overflow water. Please allow for at least 3 feet of clearance around the perimeter of the spa to provide enough room to access for servicing. Contact your local dealer for their specific requirements.

**WARNING** – The spa should be covered with an approved locking cover when not in use, to prevent unauthorized entry and injuries.

**WARNING** – People with infections, sores or the like should not use the spa. Warm and hot water temperatures may allow the growth of infectious bacteria if not properly disinfected.

**CAUTION** – Safe temperatures for swimming or aquatic exercise is around 80°F (26.7°C).

**CAUTION** – Risk of Electrical Shock. Do not leave audio compartment open. Audio CD controls are not to be operated while inside the spa.

**CAUTION** – Replace components only with identical components.

**WARNING** – Risk of Electric Shock. Do not connect any auxiliary components (for example, additional speakers, headphones, additional audio/ video components etc.) to the system. These units are not provided with an outdoor antenna.

Do not service this product yourself as opening or removing covers may expose you to dangerous voltage or other hazards. Refer all servicing to qualified service personnel. If the power supply cord(s) are damaged, water is entering the speaker, audio compartment, or any other component in the electrical equipment compartment area, the protective shield is showing signs of deterioration, or there are signs of other potentially hazardous damage to the unit, turn off the circuit breaker from the wall and refer servicing to qualified personnel.



<b>NO DIVING</b>	<b>DANGER: DIVING MAY RESULT IN SERIOUS INJURY OR DEATH.</b>	
------------------	--	---

## **IMPORTANT SAFETY INSTRUCTIONS (CONT.)**

The unit should be subjected to periodic routine maintenance once every quarter to make sure that the it is operating properly.

**DANGER** – Risk of Electric Shock. A green colored terminal or a terminal marked G, GR, Ground, Grounding or the symbol shown in Figure 14.1 of UL 1563 is located inside the supply terminal box or compartment. To reduce the risk of electric shock, this terminal must be connected to the grounding means provided in the electric supply service panel with a continuous copper wire equivalent in size to the circuit conductors supplying this equipment.

At least two lugs marked “Bonding Lugs” are provided on the external surface or on the inside of the supply terminal box or compartment. To reduce the risk of electric shock, connect the local common bonding grid in the area of the spa to these terminals with an insulated or bare copper conductor not smaller than 10AWG.

All field installed metal components such as rails, ladders, drains, or other similar hardware within 10 feet (3m) of the spa shall be bonded to the equipment grounding bus with copper conductors not smaller than 10AWG.

## **SAVE THESE INSTRUCTIONS**

## SAFETY INSTRUCTIONS

---

**WARNING:** CHILDREN SHOULD NOT USE SPAS OR HOT TUBS WITHOUT ADULT SUPERVISION.

**AVERTISSEMENT:** NE PAS LAISSER LES ENFANTS UTILISER UNE CUVE DE RELAXATION SANS SURVEILLANCE.

**WARNING:** DO NOT USE SPAS OR HOT TUBS UNLESS ALL SUCTION GUARDS ARE INSTALLED TO PREVENT BODY AND HAIR ENTRAPMENT.

**AVERTISSEMENT:** POUR ÉVITER QUE LES CHEVEUX OU UNE PARTIE DU CORPS PUISSENT ÊTRE ASPIRES, NE PAS UTILISER UNE CUVE DE RELAXATION SI LES GRILLES DI PRISE D'ASPIRATION NE SONT PAS TOUTES EN PLACE.

**WARNING:** PEOPLE USING MEDICATIONS AND/OR HAVING AN ADVERSE MEDICAL HISTORY SHOULD CONSULT A PHYSICIAN BEFORE USING A SPA OR HOT TUB.

**AVERTISSEMENT:** LES PERSONNES QUI PRENNENT DES MÉDICAMENTS OU ONT DES PROBLÈMES DE SANTÉ DEVRAIENT CONSULTER UN MÉDECIN AVANT D'UTILISER UNE CUVE DE RELAXATION.

**WARNING:** PEOPLE WITH INFECTIOUS DISEASES SHOULD NOT USE A SPA OR HOT TUB.

**AVERTISSEMENT:** LES PERSONNES ATTEINTES DE MALADIES INFECTIEUSES NE DEVRAIENT PAS UTILISER UNE CUVE DE RELAXATION.

**WARNING:** TO AVOID INJURY EXERCISE CARE WHEN ENTERING OR EXITING THE SPA OR HOT TUB.

**AVERTISSEMENT:** POUR ÉVITER DES BLESSURES, USER DE PRUDENCE EN ENTRANT DANS UNE CUVE DE RELAXATION ET EN SORTANT.

**WARNING:** DO NOT USE DRUGS OR ALCOHOL BEFORE OR DURING THE USE OF A SPA OR HOT TUB TO AVOID UNCONSCIOUSNESS AND POSSIBLE DROWNING.

**AVERTISSEMENT:** POUR ÉVITER L'ÉVANOUISSEMENT ET LA NOYADE ÉVENTUELLE, NE PRENDE NI DROGUE NI ALCOOL AVANT D'UTILISER UNE CUVE DE RELAXATION NI QUAND ON S'Y TROUVE.

**WARNING:** PREGNANT OR POSSIBLY PREGNANT WOMEN SHOULD CONSULT A PHYSICIAN BEFORE USING A SPA OR HOT TUB.

**AVERTISSEMENT:** LES FEMMES ENCEINTES, QUE LEUR GROSSESSE SOIT CONFIRMÉE OU NON, DEVRAIENT CONSULTER UN MÉDECIN AVANT D'UTILISER UNE CUVE DE RELAXATION.

**WARNING:** WATER TEMPERATURE IN EXCESS OF 38 °C MAY BE INJURIOUS TO YOUR HEALTH.

**AVERTISSEMENT:** IL PEUT ÊTRE DANGEREUX POUR LA SANTÉ DE SE PLONGER DANS DE L'EAU A PLUS DE 38 °C.

**WARNING:** BEFORE ENTERING THE SPA OR HOT TUB MEASURE THE WATER TEMPERATURE WITH AN ACCURATE THERMOMETER.

**AVERTISSEMENT:** AVANT D'UTILISER UNE CUVE DE RELAXATION MESURER LA TEMPÉRATURE DE L'EAU À L'AIDE D'UN THERMOMÈTRE PRÉCIS.

## SAFETY INSTRUCTIONS

---

**WARNING:** DO NOT USE A SPA OR HOT TUB IMMEDIATELY FOLLOWING STRENUOUS EXERCISE.

**AVERTISSEMENT:** NE PAS UTILISER UNE CUVE DE RELAXATION IMMÉDIATEMENT APRÈS UN EXERCISE FATIGANT.

**WARNING:** PROLONGED IMMERSION IN A SPA OR HOT TUB MAY BE INJUROUS TO YOUR HEALTH.

**AVERTISSEMENT:** L'UTILISATION PROLONGÉE D'UNE CUVE DE RELAXATION PEUT ÊTRE DANGEREUSE POUR LA SANTÉ.

**WARNING:** DO NOT PERMIT ELECTRIC APPLIANCES (SUCH AS LIGHT, TELEPHONE, RADIO, OR TELEVISION) WITHIN 1.5 M OF THIS SPA OR HOT TUB.

**AVERTISSEMENT:** NE PAS PLACER D'APPAREIL ÉLECTRIQUE (LUMINAIRE, TÉLÉPHONE, RADIO, TÉLÉVISEUR, ETC) À MOINS DE 1.5 M DE CETTE CUVE DE RELAXATION.

**CAUTION:** MAINTAIN WATER CHEMISTRY IN ACCORDANCE WITH MANUFACTURER'S INSTRUCTION.

**ATTENTION:** LA TENEUR DE L'EAU EN MATIÈRES DISSOUTES DOIT ÊTRE CONFORME AUX DIRECTIVES DU FABRICANT.

Hyperthermia occurs when the internal temperature of the body reaches a level several degrees above the normal body temperature of 98.6 °F (37 °C). The symptoms of hyperthermia include drowsiness, lethargy, and an increase in the internal temperature of the body. The effects of hyperthermia include:

- (a) unawareness of impending hazard;
- (b) failure to perceive heat;
- (c) failure to recognize the need to exit spa;
- (d) physical inability to exit spa;
- (e) fetal damage in pregnant women; and
- (f) unconsciousness and danger of drowning.

**WARNING:** THE USE OF ALCOHOL OR DRUGS CAN GREATLY INCREASE THE RISK OF FATAL HYPERTHERMIA IN HOT TUBS AND SPAS.

**AVERTISSEMENT:** LA CONSOMMATION D'ALCOOL OU DE DROGUE AUGMENTE CONSIDÉRABLEMENT LES RISQUES D'HYPERTHERMIE MORTELLE DANS UNE CUVE DE RELAXATION.

# SAFETY INSTRUCTIONS

---

For spas relying on a specific means of egress, such means shall not be removed when the spa is in use.

**DANGER** – This appliance is not intended for use by persons (including children) with reduced physical, sensory or mental capabilities, or lack of experience and knowledge, unless they have been given supervision or instruction concerning use of the appliance by a person responsible for their safety.

Children should be supervised to ensure that they do not play with the appliance.



**Safety graphical symbol ISO 20712-1, WSM002 – Keep children under supervision in the aquatic environment**

**DANGER** – Risk of Accidental Drowning (especially children under 5 years). Caution shall be exercised to prevent unauthorized access to the spa by children. This can be reached by an adult supervisor securing the means of access or installing a safety protection device to the spa. To avoid accidents during spa use, ensure that children are kept under constant adult supervision).

Avoid putting the head under water at all times.

Avoid swallowing spa water.

**DANGER** – No Diving.



**Safety graphical symbol ISO 20712-1, WSP005 – No Diving**

# REGULATIONS

---

Below are important requirements that you should be aware of prior to using and operating your spa per European Standard EN 17125:2018.

## MEANS OF ACCESS AND SPA ACCESSORIES

All accessories that are supplied shall be safe and compatible with the spa as required by section 4.3 of EN17125. The user can only use accessories exclusively provided by the spa manufacturer (i.e. Master Spas manufactured insulating cover) for safety reasons (section 6.1 d).

Means of access is not provided with the spa. Accessories necessary for means of access must meet European standard EN 17125. The type of means of access to the spa must be considered (ingress and/or egress where not obvious). Access means can be either secured or unsecured.

See Accessory Manufacturer Specifications for the following:

- The commercial name or reference;
- An indication of the maximum allowable weight permitted on the means of access;
- Illustrations repeating the overall dimensions of the product;
- Stepping height and width of the wall, if appropriate for ingress and egress;
- If appropriate, any indication concerning the construction of onsite reinforcement works for installing the means of access;
- The warranty period(s) of the means of access;
- Proper care instructions for winterization.

**NOTE:** A handrail may be proposed with the means of access in case of use by people with mobility issues.

Consult manufacturer or contractor for proper care during winterization and to review maximum weight allowed. Means of access shall not be used for any purpose besides for spa entry. Stairs used for entry to the spa/swim spa must comply with section 4.6.4 of EN 17125.

A cover lifter, when applicable, should be designed to keep the cover off the ground when in use, to avoid dirt and debris getting on the cover.

## ELECTRICAL REQUIREMENTS OF SPA ACCESSORIES

Electrically operated accessories shall comply with electrical safety standards and regulations (national and European). They must be assembled in accordance with the manufacturer's manual. The electrical installation of any material related to the spa and its surroundings shall comply with national requirements.

## SAFETY DEVICES

- A safety cover or other safety protection device(s) shall be used, or all doors and windows (where applicable) shall be secured to prevent unauthorized access to the spa.
- Barriers, covers, alarms, or similar safety devices are helpful aids, but they are not substitutes for continuous and competent adult supervision.

## SAFETY EQUIPMENT

- It is recommended to keep rescue equipment (e.g. a ring buoy) by the spa (if appropriate).
- Keep a working phone and a list of emergency phone numbers near the spa.

# REGULATIONS

---

## SAFE USE OF THE SPA

- Encourage all users especially children to learn how to swim.
- Learn Basic Life Support (Cardiopulmonary Resuscitation - CPR) and refresh this knowledge regularly. This can make a life-saving difference in the event of an emergency.
- Instruct all spa users, including children, what to do in case of an emergency.
- Never dive into any shallow body of water. This can lead to serious injury or death.
- Do not use the spa when using alcohol or medication that may impair the bather's ability to safely use the spa.
- When covers are used, remove them completely from the water surface before entering the spa.
- Protect spa occupants from water related illnesses by advising them to keep the water treated and to practice good hygiene. Consult the water treatment guidelines in the user's manual.
- Store chemicals out of the reach of children.
- Use the signage provided on the spa or within 2 000 mm (78.74 in) of the spa in a prominent visible position.
- Removable ladders, when removed, shall be stored safely where children cannot climb on them.

## NON SWIMMERS SAFETY

- Continuous, active, and vigilant supervision of weak swimmers and non-swimmers especially in exercise spas, by a competent adult is required at all times (remembering that children under five years of age are at the highest risk of drowning).
- Designate a competent adult to supervise the spa each time it is being used.
- Weak swimmers or non-swimmers should wear personal protection equipment, especially when using the exercise spa.
- When the spa is not in use, or unsupervised, remove all toys from the spa and its surrounding area to avoid attracting children to the spa.

## PERMISSIBLE OPENINGS

Requirements on the size of the accessible openings shall be as follows.

### OPENINGS PRESENTING A RISK OF ENTRAPMENT OF FINGERS, TOES, HANDS, FEET:

- If the lowest point of the opening is located up to and including the first 500 mm of the designed water surface, no requirements will apply;
- If the lowest point of the opening is located more than 500 mm below the designed water surface, the requirements of EN 16582-1 (domestic pools) will apply with the following exception: Hydro-massage jets with opening diameters > 8 mm or < 25 mm are also allowed below 500 mm of the designed water depth, when they are installed in designated seating/lounging areas including foot massage jets and provided with the warning sign with icon below about the risk of finger entrapment.



EN 17125 – Do not put finger in massage jet

- If the depth of penetration is less than 10 mm, no requirements apply.

### OPENINGS PRESENTING A RISK OF ENTRAPMENT OF HEAD OR NECK:

If the opening is fully located under the water surface, permissible opening requirements of EN 16582-1 (domestic pools) will apply.

# REGULATIONS

---

## USE OF NON-WATER TREATMENT CHEMICALS

For chemicals unrelated to water maintenance/treatment (i.e. cleaning products and aromatherapy), only use appropriate chemicals approved by the applicable regulations and the chemicals referenced in this manual.

## SPA SURROUNDINGS

Barefoot areas and relaxing areas shall be considered in the cleaning process as well. No cleaning water may flow into the spa or spa water cycle. The dirt and cleaning agents shall be rinsed carefully to drain to surrounding areas away from the spa.

## OPERATIONAL ADVICE

- To allow good circulation when the spa purges and filters so that chemically treated water flushes through all plumbing; all jets should be left in their open position, air controls/ aeration valves closed and water diverters adjusted to half way (diverting water to all jets).
- Whenever the spa is emptied, the filter(s) should be cleaned (and drained/dried, where applicable).
- In the absence of automated and/or continuous water treatment (measurement and chemical dosage) any manual dosing of chemicals shall not be performed while bathers are present in the spa.
- Where an automatic system is installed, periodic checks are still required as per Water Maintenance instructions in this manual.
- Master Spas recommends fast dissolving chlorine granules (sodium dichlor). It is not recommended that chlorine tablets and a floater be used.

## ENERGY EFFICIENCY ADVICE

In order to minimize energy consumption in everyday use of the spa, always use an insulating cover to minimize calorific losses at the water surface (due to evaporation, convection and conduction) when the spa is not in use.

**NOTE:** The recommended minimum thermal specifications of an insulating cover is 5"-3" thickness taper with 1.25 lb density foam.

## COMPLIANCE

---

Relax and rest assured that your Master Spas manufactured spa has been built with safety in mind. We manufacture our self-contained spas to meet a stringent list of industry standards.

Our spas comply with the following industry standards:

- UL 1563 Standard for Electric Spas, Equipment Assemblies and Associated Equipment
- ICC ISPSA International Swimming Pool & Spa Code
- European Standard EN 17125 for Domestic Spas/Whirlpool Spas/Hot Tubs – Safety Requirements and Test Methods
- VGB Virginia Graeme Baker Pool and Spa Safety Act (Certified by UL to UL 1563)
- ANSI/APSP-6 Standard for Portable Spas
- ANSI/APSP/ICC-14 Standard for Portable Spa Energy Efficiency
- CEC Title 20 Appliance Efficiency Regulation
- CSA C22.2 No. 218.1 Spas, Hot Tubs and Associated Equipment
- CE - EN 60335-2-60 Household and Similar Electrical Appliances – Safety: Particular Requirements for Whirlpool Baths and Whirlpool Spas
- CE - EN 60335-1 Household and Similar Electrical Appliances – Safety: General Requirements
- 93/68/EEC CE Marking Directive
- 2014/35/EU Low Voltage Directive
- 2014/30/EU EMC Directive
- AS1926.3-2010 RC2016
- 2014/53/EU Wireless Directive
- UKCA Electromagnetic Compatibility Regulations 2016
- UKCA Electrical Equipment (Safety) Regulations 2016
- UKCA Radio Equipment Regulations 2017
- UKCA The Restriction of the Use of Certain Hazardous Substances in Electrical and Electronic Equipment Regulations 2012
- EU REACH Compliant





# VGB SUCTION SAFETY & MAINTENANCE INSTRUCTIONS

---

## VGB 2008:

### WARNING



Read and follow all instructions in this manual and on the suction fitting. Failure to follow instructions can cause severe injury and/or death.



Failure to remove pressure test plugs and/or plugs used in winterization of the spa/swim spa from the suction outlets can result in an increased potential for suction entrapment.



Suction outlet components have a finite life. The cover/grate should be inspected frequently and replaced at least every seven years, or if found to be damaged, broken, cracked, missing, or not securely attached.



If the fitting is missing or broken, replace with a fitting of equivalent rating or higher. Use of a lower rated suction fitting could result in entrapment of the body which could result in serious injury including drowning.



Do not use or operate spa/swim spa if this suction fitting is missing, broken or not secured per instructions. The suction fitting is intended to prevent entrapment of the body. Use of the spa/swim spa with a missing, broken or improperly secured suction grate may result in serious personal injury including drowning.



When the spa/swim spa is in operation, suction is created at this fitting. Users of the spa/swim spa must be instructed not to come in contact with this fitting in such a way as to block its orifice. If a user of the spa/swim spa blocks this fitting with his/her body, serious personal injury or drowning may occur.

## IMPORTANT SAFETY INSTRUCTIONS



### WARNING - SUCTION ENTRAPMENT HAZARD

Suction in suction outlets and/or suction outlet covers which are damaged, broken, cracked, missing, or unsecured can cause severe injury and/or death due to the following entrapment hazards:

**Hair Entrapment:** Hair can become entangled in suction outlet cover.

**Limb Entrapment:** A limb inserted into an opening of a suction outlet sump/fitting or suction outlet cover that is damaged, broken, cracked, missing, or not securely attached can result in a mechanical bind or swelling of the limb.

**Body Suction Entrapment:** A negative pressure applied to a large portion of the body or limbs can result in an entrapment.

**Evisceration/Disembowelment Entrapment:** A negative pressure applied directly to the intestines through an unprotected suction outlet sump or suction outlet cover which is damaged, broken, cracked, missing, or unsecured can result in evisceration / disembowelment entrapment.

**Mechanical Entrapment:** There is potential for jewelry, swimsuit, hair decorations, finger, toe, or knuckle to be caught in an opening of a suction outlet cover resulting in mechanical entrapment.

## VGB SUCTION SAFETY & MAINTENANCE INSTRUCTIONS

---

### TO REDUCE THE RISK OF ENTRAPMENT HAZARDS:

- Never use a spa/swim spa if any suction outlet component is damaged, broken, cracked, missing, or not securely attached.
- Replace damaged, broken, cracked, missing, or not securely attached suction outlet components immediately.
- It is recommended that suction components be inspected at least monthly.
- Replace the suction within 7 years from the installation date. Contact your dealer or local service center for quoting and scheduling this required maintenance. This is a mandated regulation and is not part of nor covered by the spa/swim spa warranty.

**NOTE:** Always review entire safety and maintenance information before beginning maintenance. Contact Master Spas for Suction Installation information for complete suction assembly replacement.

# GLOSSARY OF SPA TERMINOLOGY

---

Your new spa features a variety of jets. All jets, regardless of style, return the water to the spa. Air is mixed with the water by using the air controls (if equipped) creating a vigorous massage. Water flow is adjusted by simply turning the outer face of most jets. Your spa may have a combination of pulsating, rotating, dual pulsating and directional adjustable jets. Here are some terms and definitions to help get you acquainted with your spa.

## 1. THERAPY JETS

Located throughout the seats of the spa to offer a variety of therapy combinations.

## 2. NECK JETS (if equipped)

Located above the normal water level to provide massaging action to the back of the neck.

## 3. SHOULDER JETS (if equipped)

Located above the normal water level to provide massaging action to the shoulders.

## 4. MASTER BLASTER® FOOT THERAPY JET (if equipped)

Large jet with several fixed nozzles located in the bottom of the spa near the floor to provide excellent massage to the feet.

## 5. JET DIVERTER VALVE\* (if equipped)

Located on the top flange of the spa, this large valve physically diverts the flow of water from one group of jets to another. Be sure that no sand or particles are brought into the spa as they will cause the diverter to seize up. It is best to turn the diverter valve only when the pump is turned off.

## 6. WATER FEATURE VALVE\* (if equipped)

Located on the top flange of the spa, this smaller valve adjusts water flow to the waterfalls and/or water features in your spa.

**NOTE:** When the spa is not in use, this valve should be turned mostly shut (not completely shut) to prevent the water features from allowing water to hit the cover while it is closed. If left mostly open, water may hit the cover and possibly run out of the spa causing water loss.



## 7. 3-WAY DIVERTER JET\* (if equipped, Getaway Hot Tubs)

This large jet can be turned 180° to 3 different points and diverts the flow of water from one group of jets to another. With the pump turned off, twist the face of this jet 1/4 turn at a time clockwise or counterclockwise to adjust.

## 8. AIR CONTROL VALVE\*

These smaller valves are located around the top of your spa. You may increase or decrease the force of your jets by opening or closing the air control valves. Each air control valve will typically function 1 to 2 groups or seats of jets in the spa. When not in use the air controls should be kept in the closed position as the air being introduced into the water can tend to cool the water and increase the dissipation rate of sanitizer levels.

**\*NOTE:** See Pump Diagrams in the back of this manual for location of valves, controls, and jets.

# GLOSSARY OF SPA TERMINOLOGY

---

## 9. TOPSIDE CONTROL PANEL

You may safely control spa functions from inside or outside your spa using the Topside Control Panel. This panel is used to control the water temperature, pumps, the spa light, automatic filtration cycles and other advanced functions. The digital display will give you a constant temperature readout and will notify you in case of certain malfunctions. Several user programmable functions are also available.

## 10. PERSONAL REMOTE CONTROL\* (if equipped)

Select spa models may have an additional remote which allows the user to control the jet therapy while remaining in the seat (if applicable). By pressing the control one time, you will activate the pump. Press again for high speed and again to turn it off.

## 11. ACCESS PANELS

These are the skirt panels located around all four sides of the spa. All of the skirt panels are removable should service be required. Master Spas recommends at least 3 feet of access be provided around the spa.

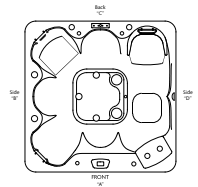

## 12. EQUIPMENT ACCESS PANEL

This is the "Front" or "A" side skirt access panel, typically the same side as the Topside Control Panel. This area houses the majority of components responsible for the spas operation. These components include the pumps, heater, spa control system, ozonator (if equipped), and LED light system (if equipped). Pump and equipment placement may vary by model.

## 13. FILTER LID

This lid fits over the filter area and weir gate to cover the filters. Remove filter lid to access filters for maintenance. For models equipped with a telescoping filter housing, simply lift up to remove this floating assembly to access the filter. At low speed water flow or when the filtering/heating pump is off, the telescoping part of the filter assembly will float at or near the waterline. At high speed water flow, it will be drawn downward. See Accessing Filters in the Regular Maintenance Procedures section for detailed instructions on filter assemblies.

## 14. WEIR GATE

The weir gate is the horizontal door located in front of the filters that helps keep debris trapped in the filter area.

## 15. SPA CONTROL SYSTEM

This houses the wiring and electrical components necessary to operate the spa.

## 16. SPA HEATER

This is an electric heater housed in a stainless steel tube. It is thermostatically controlled and equipped with high-limit temperature safety shut-off sensors.

\*NOTE: See Pump Diagrams in the back of this manual for location of valves, controls, and jets.

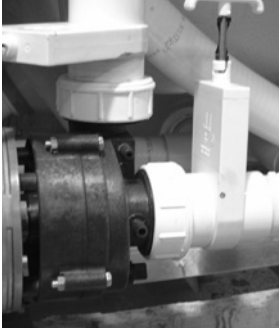

Slice Valve and Pump Union

### 17. SLICE VALVES

These valves are used by service personnel to shut off water to the heating system (heater and pump plumbed to the heater) so that the spa water does not need to be drained if the spa requires service to the heating system (varies by model).

**NOTE:** Slice valves must be completely open during normal operations.

### 18. MAIN THERAPY PUMP

This produces water flow through the main jets in the spa. The first pump may be operated on two speeds (varies by model). Low speed (if applicable) will produce efficient water circulation during filtration, heating of the spa water, and gentle jet action. High speed provides maximum jet action. The main pump is controlled by the “Jets” or “Jets I” button on the Topside Control Panel.

### 19. SECONDARY THERAPY PUMP (if equipped)

This produces water flow through 1 to 2 groups or seats of jets in the spa. The second pump operates similar to the main pump and is controlled by the “Jets 2” or “Aux” button on the Topside Control Panel.

### 20. THIRD THERAPY PUMP (if equipped)

This produces water flow through 1 to 2 groups or seats of jets in the spa. This is controlled by the “Jets 3” button on the Topside Control Panel.

### 21. CIRCULATION PUMP (if equipped)

This produces water flow through the heater in the spa and provides the water flow necessary to actuate the ozone injector. This smaller energy efficient pump is used for filtration and heating instead of utilizing the high powered main therapy pump.

### 22. PUMP UNION

This connects the plumbing and pump together. These are used to help relieve possible pump air locks or for service personnel to easily service the pumps.

### 23. HEATER UNION

These are used by service personnel to easily service the heater.

## THE ADVANTAGES OF ECOPUR® CHARGE

---

# ECOPUR® CHARGE

MASTER CORE TECHNOLOGY

The EcoPur® Charge\* is made from Master Spa's patented filtration fabric. This fabric is wound tightly into a nautilus master core, creating a catalytic cell. The nautilus fabric cell is encased by a unique "spring core" that allows for maximum flow and water "charging". As water comes in contact with the EcoPur® Charge Master Core, a chemical reaction causes zinc and copper hydroxides to form in controlled amounts. Like Mother Nature, when controlled releases of copper and zinc oxides are carried into the filtered water, they kill bacteria and provide hostile conditions for algae and fungal growth. Using EcoPur® Charge helps reduce the amount of chemicals needed, therefore safeguarding the hot tub's plumbing and equipment because pipes are protected against the corrosive effects of chlorine. EcoPur® Charge Master Core Technology is another exclusive design by Master Spas.

### FEATURES

- Releases Sanitizing Copper & Zinc Oxides
- Reduces Water Soluble Heavy Metals
- Controls Scale, Bacteria and Algae
- Safeguards the Spa's Plumbing
- Reduces Use of Chemicals
- Helps Prevent Damage to Swimwear



\*PATENTS PENDING

# THE ADVANTAGES OF ECOPUR® CHARGE

---

## ECOPUR® CHARGE INSTALLATION

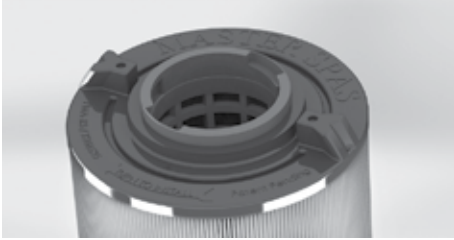

Master Spas Outer Filter\*



EcoPur® Charge\*

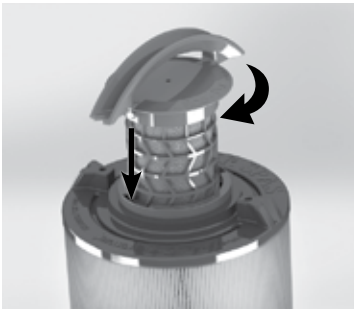

Turn Clockwise to Lock

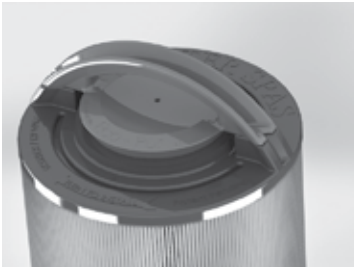

### STEPS FOR INSTALLATION

1. Insert EcoPur® Charge into outer filter.
2. Twist EcoPur® Charge clockwise to lock in place while holding on to outer filter. When snapped in to locked position, EcoPur® Charge handle aligns with molded points on outer filter.

**NOTE:** EcoPur® Charge should be replaced every 6 months. Initial snap in fit of inner EcoPur® Charge to outer filter may be tight, especially if both are new.



\*PATENTS PENDING

Before jumping into Water Maintenance, here are some terms to help you.

- 1. PARTS PER MILLION (PPM):** This is a form of measurement used in most pool or spa chemical readings. Best described as any one million like items of equal size and make up, next to one unlike item, but of equal size. This would be one part per million.
- 2. TOTAL ALKALINITY:** Measures substances in your water such as hydroxides, carbonates and bicarbonates. When at the proper levels, these elements keep your water from clouding and growing bacteria, as well as prevent the inner workings of your hot tub from deteriorating or forming scale. TA also helps to stabilize pH. The higher the TA level (as long as it is within the recommended range), the less likely the pH is to change. With low alkalinity, the pH will fluctuate and be harder to control. With high alkalinity, it becomes extremely difficult to change the pH.
- 3. PH OR POTENTIAL HYDROGEN:** This indicates the acidity or basicity of the water. The goal is to have a neutral, stable pH to prevent spa damage and unhealthy conditions. Low pH levels can corrode metals, etch or stain fiberglass or acrylic, cause unsanitary conditions that irritate the eyes or skin and destruct the total alkalinity of the water. High pH can cause cloudy water, eye or skin irritation, scale formation and poor chlorine or bromine efficiency. Note that the chemicals you are using to sanitize and clean your hot tub can also lower or raise the pH level in the water. Unfortunately, there are lots of variables to preventing high pH in your hot tub.
- 4. SHOCKING:** By shocking the water in your hot tub, you remove organic compounds from the water, kill bacteria, remove bromamines or chloramines and reactivate the bromides in the spa for cleaner water. You should shock your water once a week, after heavy bather use or any time free chlorine levels test lower than total chlorine levels. To do this, either add oxidizer/non-chlorine shock to burn off the chloramines or add extra chlorine to raise the chlorine level. Oxidizer/non-chlorine shock acts by releasing oxygen in the water, which serves a similar function as chlorine. An advantage to using this type of shock is that the water is safe to enter after 15 minutes of the application and excessive sanitizer (chlorine) levels do not occur. However, an oxidizer/non-chlorine shock doesn't disinfect the water for bacteria. If you use chlorine to shock, you must wait until the total chlorine reading is at a level safe to reenter the water.
- 5. SEQUESTERING:** This can be defined as the ability to form a chemical complex which remains in solution, despite the presence of a precipitating agent (i.e. calcium and metals). If the minerals and metals in water are not sequestered, they can cause a reaction, turning the water brown, red, orange or green depending on the minerals and metals present in your water. It is important to add a sequestering agent when adding water to your spa and even on a regular basis (if bottle instructions recommend doing so). Common names for sequestering chemicals are: minquest, stain and scale control, metal-x, spa defender, spa metal gone, etc.
- 6. FILTRATION:** Filters are necessary to remove particles of dust, dirt, algae, etc., that are continuously entering the water. If the spa is not operated long enough each day for the filter to do a proper job, this puts a burden on the chemicals, causing extra expense. Filtration time will depend on the water capacity, pump and filter size and, of course, bather load. Spare filter cartridges should be kept on hand to make it easy to frequently clean the cartridge without the need for a long shut down. This will also allow the cartridge to dry out between usages, which will increase the cartridge life span as much as twice. Replace the cartridge when the pleats begin to deteriorate. Cartridge cleaning should be done a minimum of once a month. More often with a heavy bather load. See *Cleaning Your Filter Elements in the Regular Maintenance* section.



## WATER CHEMISTRY TERMS YOU SHOULD KNOW

---

7. **SANITIZERS:** Germs and bacteria enter the water from the environment and the human body; a sanitizer keeps the water balanced and safe to use. Either chlorine or bromine can be used as a sanitizer to create a healthy water environment.
- A. Chlorine:
1. Only one type is approved for spa use. Sodium dichlor which is granular, fast dissolving and pH neutral chlorine.
  2. Chlorine is an immediate sanitizer and will be added as needed to maintain free chlorine levels.
- B. Bromine
1. Two types of tablets:
    - a. Hydrotech
    - b. Lonza
  2. Bromine is a slow dissolve chemical and may take a few days to develop a reserve or reading in the water.
- NOTE:** Bromine use is not recommended with EcoPur<sup>®</sup> filters as it can hinder being able to maintain proper reserve/residual levels for maintaining sanitary conditions.
- WARNING:** Nonslip, Comfort Floor System mats are not compatible with bromine and will result in unwarranted deterioration of the material. Do not use bromine if your spa is equipped with these mats.
8. **TOTAL DISSOLVED SOLIDS (TDS):** Materials that have been dissolved by the water, i.e. like what happens when you put sugar in coffee or tea.
9. **USEFUL LIFE OF WATER (IN DAYS):** Water should be drained at least once every 180 days. Useful life may vary by usage and bather load.
10. **DEFOAMER:** A chemical used to temporarily reduce foaming. Causes of foaming include body oils, cosmetics, lotions, surface cleaners, high pH or algae, as well as other organic materials. Low levels of calcium or sanitizer can also cause increased foaming. Note that you may need to physically remove the foam and/or drain all or part your water to remove or dilute the causes of the foam.
11. **CALCIUM HARDNESS:** This measurement tells you how much magnesium and calcium are in your water. However, calcium hardness can react with all of the chemicals, bacteria, dirt and other substances that your water dissolves and get thrown out of balance. Just like the other elements, calcium levels must remain balanced and need to be monitored or you run the risk of metal deterioration, water foaming or clouding and scale formation at the surface of your water.
- NOTE:** Always leave spa cover open for 15 minutes after adding chemicals to prevent the off gas from damaging your spa cover, spa pillows, stainless steel hardware and other critical parts.
12. **BIOFILM:** This is any group of microorganisms in which cells stick to each other and often these cells adhere to a surface (ie. spa plumbing and shell). Biofilm can occur over time during the use of your spa.

# WHY ARE CHEMICALS IMPORTANT IN A SPA

---

## 1. EVAPORATION:

As water evaporates, only pure water evaporates, leaving the salts, minerals, metals, and any unused chemicals behind. Adding water adds more salts, minerals, and metals. In time, the water can become saturated with these dissolved solids and can cause stains or scale to form on the walls of the spa or a scale build up inside the equipment. Colored or cloudy water and possible corrosion of plumbing and fittings may also occur.

## 2. HEAT:

Heat causes much quicker evaporation and also will cause minerals and metals to precipitate out of solution.

## 3. AIR:

Dust and other airborne contaminants are introduced into the spa.

## 4. ENVIRONMENT:

The environment surrounding the spa can also impact the water quality. Items such as pollen, grass, sand, dirt, lawn fertilizer, airborne dust, insects, leaves, and pets can all affect the water quality of the spa.

## 5. BATHERS:

As the spa is used, bathers introduce contaminants to the water. Increased bather load, length of use and frequency will increase the amounts of contaminants added in to the water.

**NOTE:** The maintenance routines set forth in this manual may need to be adjusted depending on bather load and how much the spa is being used.

## WATER MAINTENANCE – RECOMMENDED RANGES

### WATER CHEMISTRY GUIDE

Before treating your water, refer to the Model Specifications section of this manual for the correct gallons of your spa, to ensure you are adding the correct amount of chemicals. The concentration of active ingredients in spa chemicals varies by manufacturer, so always consult chemical manufacturer's instructions. When adding spa chemicals, always spread them across the surface of the water while the pumps are running. See chart below for recommended ranges.

BS EN 17125:2018

PARAMETER	VALUE <sup>A</sup>
Water Clarity	Clear view of the bottom
Color of Water	No color should be observed <sup>b, c</sup>
Turbidity in FNU/NTU	max. 1,5 (preferably less than 0,5)
Nitrate concentration above that of fill water (in mg/l)	max. difference of 20 compared to the fill water concentration
Total organic carbon (TOC) (in mg/l) <sup>d</sup>	max. 4,0
Redox potential against Ag/AgCl 3,5 M KCl in mV	min. 650
pH value <sup>e, f</sup>	6,8 to 7,6
Free active chlorine (without cyanuric acid) (in mg/l)	0,3 to 1,5 <sup>g</sup>
Free chlorine used in combination with cyanuric acid (in mg/l)	1,0 to 4,0 <sup>g</sup>
Cyanuric acid (in mg/l)	max. 100 <sup>h</sup>
Combined chlorine (in mg/l)	max 0,5 <sup>i</sup> (preferably close to 0,0 mg/l)
Bromine (in mg/l)	2,0 to 4,0 <sup>g</sup>
When using alternative/additional disinfectants other appropriate parameters may be considered.	
<sup>a</sup> Consult national regulations and guidelines for any deviations.	
<sup>b</sup> Natural water sources may introduce water colouration.	
<sup>c</sup> Intentional water colouration is excluded.	
<sup>d</sup> When using organic compounds this value may be higher.	
<sup>e</sup> Subject to the flocculant(s) used (if any).	
<sup>f</sup> When pH is greater than 7,5 the free active chlorine is less than 50 %.	
<sup>g</sup> Temporary exceeding due to manual dosage and low water volume to user ratio is acceptable, provided the health of the user is not compromised.	
<sup>h</sup> If national regulations allow > 100 mg/l then a suitable treatment should be applied (e.g. dilution).	
<sup>i</sup> If national regulations allow > 0,5 then a suitable treatment should be applied (e.g. dilution)	

**NOTE:** The Indicative physical and chemical parameters when using chlorine disinfectant outlined in this manual are specified to comply per EU regulation (BS EN 17125:2018). Regulatory agencies in countries outside of the EU may require different values than what is outlined here. If the spa is installed in a country outside of the EU, check with your local regulatory body for recommended chemical levels in your area. Improper use of chemicals may result in unsanitary and unsafe water conditions as well as unwarranted discoloration, degradation, damage and other imperfections of the spa surface and components.

 WATCH HOW-TO VIDEOS: [masterspas.com/video-tutorials](http://masterspas.com/video-tutorials)

## START UP STEPS

1. Your spa should be filled with fresh tap water using a Pre-filter, which can be obtained from your local Master Spas dealer. This Pre-filter will help remove many of the minerals existing in the water, which will make adjusting the water balance easier after a new fill. Never use more than 50% softened water when filling the spa.
2. During the initial filling of the spa, add a sequestering agent to combat suspended minerals in the water. The agents are sold under many different names such as Mineral Clear or Metal Protect. Always follow the instructions listed on the bottle and allow water to circulate and filter for at least 30 minutes (or per bottle recommendations) before adding any other chemicals.
3. Test water for pH, total Alkalinity, and Calcium hardness. There are two different methods you can use to test your water.

**TEST STRIPS:** The pads on these thin strips react by changing colors when you dip them in the hot tub water. To avoid faulty test results, use care when removing a testing strip from the packaging. Open the package and shake one strip out into your hand, avoiding contact if possible with the remaining strips. Seal the container immediately so the remaining strips are not exposed to moisture. Dip the test strip into the water and follow the instructions supplied with test strips as instructions may vary. Note the colors on your testing strip and compare these to the key found on the packaging to determine whether elements are neutral, too high or too low.

**TESTING KIT:** When using a testing kit, you will be examining an actual water sample from your hot tub, rather than a strip. Be careful to follow the instructions on your kit, filling the container to the appropriate level and then dropping the instructed liquid into the container. Compare the new color of your water to the key provided with the kit to determine how to proceed. Depending on which kit you purchase, it can test for each one of these elements: total alkalinity, pH, chlorine, bromine and calcium hardness.

4. Adjust pH and total Alkalinity (TA) utilizing the directions on the chemical bottles. Wait 15 minutes, test and adjust if necessary.
5. It may be necessary to retest and add additional chemicals to get to the proper levels.
6. Add concentrated chlorinating granules (sodium Dichlor-s-triazinetreone) on initial start up to begin sanitizing the spa water, according to directions on chemical bottle. Bathers should not enter the spa until the chlorine drops to a safe level, refer to Water Chemistry Guide in this section. It is important not to add the chlorinating granules until the pH, alkalinity and calcium hardness have been adjusted to their proper levels.

**NOTE:** See the Model Specifications section of this manual for the correct gallons of your spa, to ensure you are adding the correct amount of chemicals. When adding chlorine or non-chlorine shock/oxidizer always spread it across the water while the pumps are running. The concentration of active ingredients in spa chemicals varies by manufacturer.



WATCH HOW-TO VIDEOS:  
[masterspas.com/video-tutorials](http://masterspas.com/video-tutorials)

▶ WATCH HOW-TO VIDEOS: [masterspas.com/video-tutorials](https://masterspas.com/video-tutorials)

### BEFORE EACH USE

Test the spa water for proper pH and sanitation levels. Adjust accordingly to the proper levels outlined in the Water Chemistry Guide, found in the Water Maintenance – Recommended Ranges section. Appropriate levels should be present before use of the spa. Bathers should not enter the spa if the chlorine levels are outside of the safe, recommended ranges.

### AFTER EACH USE

Test water and treat accordingly to maintain proper pH and free chlorine levels for continued sanitary conditions after use. The amount of people using the spa (and duration of use) will deplete chlorine levels and can cause free chlorine to test below total chlorine, resulting in a more frequent need to use an oxidizer/non-chlorine shock treatment.

### 3 TIMES A WEEK

Test the water using chemical test strips. Adjust sanitizer, pH and Alkalinity accordingly, following directions on the chemical manufacturer's bottle. If free chlorine level measures less than total chlorine level, additional non-chlorine shock/oxidizer treatment is necessary.

### ONCE A MONTH

Soak your regular filter elements overnight in a container with spa Filter Cleaner and then rinse with clean water. For best results, allow the filter to dry before re-inserting. (The EcoPur® element should never be cleaned in a filter cleaner. Just rinse with water.) When cleaning filters, be sure to never have the pumps (including the circulation pump) running without the filters in place. Failure to do so may result in debris being drawn into the pumps causing unwarranted damage. See Cleaning Your Filter Elements in the Maintenance section of this manual for more information.

### EVERY 180 DAYS

Drain and refill your spa with fresh water, install a new EcoPur® element, clean the regular filter, and repeat start up procedure. The regular filter should be replaced at least once every year. Over time and bather use, biofilm buildup can occur. Chemical products are available to help remove biofilm and should be used periodically before draining.

### AS NEEDED

If the water looks hazy, make sure pH is in the proper range and treat with chlorinating granules to maintain free chlorine levels. Treat with non-chlorine shock (oxidizer shock) if free chlorine is less than total chlorine. Always refer to the chemical manufacturer's dosage recommendations listed on the container. Free chlorine levels should be maintained per the Water Chemistry Guide.

A defoamer may be used when excessive foaming occurs. Over use of a defoamer will result in cloudy, milky water. These are general recommendations for water maintenance that may vary by usage and bather load. Depending on bather load and frequency of use, drain and refill times may vary as well as the frequency of cleaning your filters.

### USE ONLY SPA CHEMICALS

Do not use chemicals designed for use in swimming pools. With a spa you are working with a small volume of hot water compared to a large volume of relatively cool water in a swimming pool. Because of this, chemicals will have a shorted life span and bacteria can grow more quickly than in a swimming pool. A spa is less forgiving than a pool and requires that whatever is put into it have a pH as close to neutral as possible. That is why only chemicals made for spas should be used. Always refer to the chemical manufacturer's dosage recommendations listed on the container.

# WATER MAINTENANCE – TROUBLESHOOTING GUIDE

EN 17125

▶ WATCH HOW-TO VIDEOS: [masterspas.com/video-tutorials](http://masterspas.com/video-tutorials)

PROBLEM	POSSIBLE CAUSES	HOW TO FIX IT
<b>CHLORINE ODOR</b>	Excessive chlorine	Shock water with oxidizer/non-chlorine shock treatment
	Low pH	Adjust pH if necessary
<b>WATER ODOR</b>	Low levels of sanitizer	Adjust sanitizer level with chlorinating granules
	pH out of range	Adjust pH if necessary
	Bacteria or algae growth	If sanitizer has already been adjusted, it may be necessary to perform a system flush
<b>CLOUDY WATER</b>	Dirty filters or inadequate filtration	Clean filters with filter cleaner and adjust filtration
	Unbalanced water chemistry	Test and adjust chemistry levels
	Old water	Drain, clean inner shell and refill with filtered water
<b>CLOUDY AND GREEN WATER</b>	Total alkalinity levels are low	Use a pH increaser
	Sanitizer levels are low	Apply oxidizer/non-chlorine shock treatment and adjust sanitizer
<b>CLEAR GREEN WATER</b>	High iron or copper content	Use a sequestering agent
	Sanitizer levels are low	Apply oxidizer/non-chlorine shock treatment
<b>BROWN WATER</b>	High iron or manganese level	Use a sequestering agent
<b>FOAMING</b>	High levels of body oils, lotions, soap, etc.	Add small amount of defoamer, an enzyme product and check water chemistry
	Low calcium hardness	Use a calcium hardness increaser
	Unbalanced water chemistry	Test and adjust chemistry levels
<b>EYE OR SKIN IRRITATION</b>	Unsanitary water	Adjust water chemistry according to testing results
	Total chlorine level above 5 ppm	Apply oxidizer/non-chlorine shock treatment
	Poor sanitizer/pH levels	Adjust pH level as necessary
<b>SCUM DEPOSITS AT WATERLINE</b>	Body oils and dirt	Use multi-purpose cleaner to clean spa surface and add enzyme product to spa water
<b>CHALKY, WHITE SCALE DEPOSITS</b>	Minerals present in the water and lack of sequestering agent use	When tub is drained, use a multi-purpose cleaner or white vinegar and scrub with a soft cloth
<b>PITTING OF METAL FIXTURES</b>	Low pH or total alkalinity	Check water chemistry and adjust

**NOTE:** Please refer to the Water Maintenance - Recommended Ranges section to review recommended chemical levels.

## REGULAR MAINTENANCE PROCEDURES

EN 17125

▶ WATCH HOW-TO VIDEOS: [masterspas.com/video-tutorials](http://masterspas.com/video-tutorials)

**NOTE:** These maintenance procedures are the responsibility of the spa owner to perform. These procedures are not covered by the spa warranty.

### DRAINING YOUR SPA

Before you start draining your spa, be sure all power is turned off to it. Your spa requires periodic draining and cleaning to ensure a safe, healthy environment. It is recommended that you clean your spa at least every 180 days or as necessary. Heavy bather load will require draining and cleaning it more often. Draining times will vary by model when using the equipped internal drain assembly. A sump pump may also be used to expedite the draining of the spa.

**NOTE:** If your hot tub required multiple electrical services, be sure to turn off breakers for all services powering the spa equipment. See model specifications and appropriate electrical requirements for your model or contact your electrician if you are not familiar with how your electrical was installed. A breaker or power cut off should always be within line of sight.

Caution and careful planning should be taken if draining in freezing temperatures to ensure the process is performed quickly (by use of a submersible pump) and that the water is either refilled quickly again or winterization steps are immediately performed. Try to plan your normal draining maintenance during times when temperatures are above freezing. Excess water in the plumbing can freeze in a short time frame depending on temperatures and conditions. Water freezing within plumbing and components can result in freeze damage which is not warranted.

### STEPS FOR USING THE EQUIPPED INTERNAL DRAIN

The spas are equipped with a drain assembly which can be located on the front side of the spa behind the skirt (same side as the topside control panel or where most of the spa equipment is located). The drain will be located in the equipment area behind the front skirt panel (Figure 1).



Figure 1



Figure 1.1

1. Remove the front skirt panel by removing its panel screws. The drain will be located inside the equipment bay (see Figure 1 & Figure 1.1).
2. To start the flow of water with this drain assembly; remove the cap, twist the face counterclockwise and pull out slightly on the face. A garden hose can be attached to the end of the drain assembly, if so desired.

**NOTE:** With the cap removed from the drain; water may drip or weep from the drain. This is normal. Be sure that the steps are followed in reverse order when draining is finished. Make sure that the drain cap is reattached and the valve is put back to the fully closed position so that there is no water leaking from the drain assembly.

### STEPS FOR USING A SUMP PUMP\*

1. Carefully lower submersible pump with hose connected into the bottom of spa, taking care not scratch or gouge your spa shell.
2. Run the discharge end of the hose from your submersible pump to a desired location several feet away from your spa, where the water will drain away from foundation that the spa is resting on.
3. Plug in/turn on your submersible pump.
4. Turn off/disconnect your submersible pump once it is no longer able to suck up any further water (indicated by a suctioning sound and water no longer coming out of the drainage hose). If you plan to fully wipe down and clean your entire spa shell, a shop vac can be used to remove the remaining small pockets of water in the spa.

\*Sump Pump is not provided with spa.

## REGULAR MAINTENANCE PROCEDURES

---

▶ WATCH HOW-TO VIDEOS: [masterspas.com/video-tutorials](https://masterspas.com/video-tutorials)

**Note: These maintenance procedures are the responsibility of the spa owner to perform. These procedures are not covered by the spa warranty.**

### SPA SURFACE CARE

- During use, always remove debris and pollutants that have settled in the water or built up on the spa surfaces as it occurs. These pollutants can cause growth of bacteria, algae, fungus or biofilm if left on the spa surface and potentially cause stains.
- Clean the spa shell, jets and other controls with a soft cloth and spa shell cleaner to help remove residue and buildup on the shell surface. For any remaining buildup, white vinegar or mild scale remover product may be necessary to use with a soft cloth for removal. Consult with your local Master Spas dealer for proper spa cleaning products.
- Rinse the cleaned surfaces with fresh water from your garden hose and wipe with a soft cloth as doing so will help to remove residual cleaning agents (as some may cause foaming to occur in the water once spa is refilled).
- Always use an approved insulating spa cover by Master Spas to cover your spa when not in use, especially in outdoor installations where the spa is exposed to weather conditions and sun. Constant, prolonged exposure and use of unapproved or non-insulating spa cover can result in damage to spa surface which would not be warranted.

### CARE OF YOUR SPA PILLOWS

- Your spa pillows should be rinsed periodically to remove chemical residue. This helps improve pillow lifespan and slows down deterioration of the pillows (i.e. discoloring, becoming stiff and flaking of the material).
- If the spa will not be used for a period of time, the pillows could be removed and rinsed to prolong their life.

**NOTE:** Do not cover the spa for 15 minutes after adding chemicals as the off gas can cause damage.

### CARE OF YOUR SPA CABINET

The spa cabinet is made from a UV resistant material. The cabinet requires only periodic cleaning with a stream of water from a garden hose. If necessary, use mild soap and water with soft cloth to wipe down cabinet surface. Rinse thoroughly.



# REGULAR MAINTENANCE PROCEDURES

## ACCESSING FILTERS

### Filter Weir with Top Access



Remove Filter Lid



Turn Filters Counter-clockwise to Remove

**NOTE:** EcoPur filter set is normally placed in filter port closest to the topside control panel, this is ideal when Mast3rPur circulation system present.

### Vane Teleweir Filter Housing



Pull Up to Remove Floater Assembly



Turn Filters Counter-clockwise to Remove

### Telescoping Filter Housing



Twist Lock Ring Counter-clockwise to Remove Floater



Remove Basket



Turn Filters Counter-clockwise to Remove

### Filter Weir with Slide Off Access



Slide Faceplate Up to Remove



Turn Filters Counter-clockwise to Remove

## REGULAR MAINTENANCE PROCEDURES

▶ WATCH HOW-TO VIDEOS: [masterspas.com/video-tutorials](http://masterspas.com/video-tutorials)

**NOTE:** These maintenance procedures are the responsibility of the spa owner to perform. These procedures are not covered by the spa warranty.

### Vane Skimmer Filter Housing



Remove Top Cap by Gently Lifting



Lift Up and Remove Basket



Turn Filters Counter-clockwise to Remove

## CLEANING YOUR FILTER ELEMENTS

The filter elements are one of the most important components of your spa. Not only are they essential for clean water; they also extend the life of the spa equipment and help avoid unnecessary water changes and re-heating. Your filter elements should be cleaned on a regular basis, at least once a month on average with normal usage. With heavy use, poor water quality and/or high dissolved solid content in water; the filters may need to be cleaned more often. It is recommended to allow filter elements to fully dry after cleaning. For this reason, it is ideal to have a spare set of filters on hand for filter cleaning intervals.

1. Turn off the spa before servicing filters. Never leave the spa running when removing the filters. Debris can be pulled into the plumbing system and cause unwarranted damage.
2. Remove filter element(s).
3. With a garden hose, spray each element under pressure. Monthly, the standard filter elements should be soaked in a filter cleaner. Do not soak EcoPur® element in a filter cleaner. The EcoPur® element should only be rinsed with fresh, clean water if necessary. Check with your Master Spas dealer for details on cleaning and/or filter replacement recommendations.
4. The EcoPur® element should be replaced every 6 months. The standard filter should be cleaned regularly and will typically last approximately 1 year. Bather load, usage and water quality will effect the longevity of the filters and require more frequent cleaning or replacement.



## CLEANING JETS

The majority of jets in your spa can individually be turned on/off. If any of these jets become hard to turn, it will be necessary to remove the jet to clean it as grit/sand and mineral deposit may be present. The jets in your spa can be removed for cleaning by turning them counter-clockwise until they release and then pulling out the jet.

**TO CLEAN JETS:** Place the jet(s) in a container, fully immerse in white vinegar. Let the jet(s) soak overnight and then rinse with water. Reinstall the jet(s). It may be necessary to clean grit and deposits from the white jet body (mounted in the spa shell) by using a small bristled brush.

## REGULAR MAINTENANCE PROCEDURES

---

**NOTE:** These maintenance procedures are the responsibility of the spa owner to perform. These procedures are not covered by the spa warranty.

### CARE OF LAMINAR FLOW JETS:

In order to keep your Laminar Flow Jets operating properly, follow these steps:

1. Turn off Laminar Flow Jets.
2. Remove outer ring by turning face counter-clockwise while pulling on it.



3. Either the whole Laminar Flow Jet Assembly pops out: Rinse it out and inspect it. Or, if only the outer ring comes off: Remove internal Jet insert with a pair of needle nose pliers and inspect it.



OR

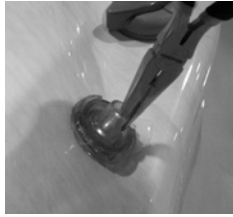

4. Clean plastic diffuser at the back of the Jet insert or Laminar Flow Jet Assembly so all holes are free of debris.
5. Reinstall Jet insert or assembly and outer ring by pushing it in and turning it clockwise until it stops.

**NOTE:** To prevent premature failure of your spa cover and the possibility of water running out of the spa off the bottom of the cover, always turn Laminar Flow Jets down so that they do not hit the cover when the cover is closed. You do not want to completely turn jets off. Doing so may cause a build up of stagnant water in the water line if not used often.



EN 17125, Do not put finger in massage jet

## REGULAR MAINTENANCE PROCEDURES

---

**NOTE:** These maintenance procedures are the responsibility of the spa owner to perform. These procedures are not covered by the spa warranty.

### CLEANING DIVERTER VALVES

Mineral deposits, grit and sand may get into the internal parts of the diverter valves over time. The diverter valves may become difficult to turn or not turn at all.

**CAUTION** – TURN OFF SPA BEFORE PROCEEDING WITH THIS MAINTENANCE.



#### FOR THESE STYLES OF HANDLES, FOLLOW THE STEPS BELOW:

1. Remove the handle from the top of diverter valve by grasping the handle and pulling up with a rocking motion.
2. Turn the cap piece counter-clockwise. It may be necessary to put a clean towel over the cap and turn it with a wrench.
3. Once loose, the cap, internal rotor assembly and handle can be pulled up out of the white plumbing fitting.
4. Wipe down the internal rotor assembly that attaches to the cap and handle.
5. Soak the internal rotor assembly in white vinegar.
6. The inner wall of the white plumbing fitting should also be wiped down. If the surface of the white plumbing has become too abrasive, you can take wet, fine sandpaper and smooth it out.
7. Rinse the diverter internals. Inspect O-rings for cracking or swelling and apply silicone lubricant to them. Then reassemble.

## REGULAR MAINTENANCE PROCEDURES

---

▶ WATCH HOW-TO VIDEOS: [masterspas.com/video-tutorials](https://masterspas.com/video-tutorials)

**Note:** These maintenance procedures are the responsibility of the spa owner to perform. These procedures are not covered by the spa warranty.

### CARE OF YOUR SPA COVER

Always cover your spa when not in use with an approved insulating spa cover by Master Spas. Keep the spa cover on to minimize heat loss during heating of the spa between uses (but not while it is being used). This will greatly reduce energy consumption and will cause spa water to heat more rapidly. Water loss and chemical usage will also be reduced.

- Ensure the cover is fitted tightly, as per manufacturer's instructions to maximize insulation.
- Be sure to lock down all straps on the cover after each use.
- Do not allow spa to sit uncovered in direct sunlight. The heat and UV from direct sun exposure can cause damage to exposed shell surfaces of the spa as well as damage or discoloration of the spa controls and fittings.
- See cover manual instructions for detailed instructions on proper cover care. Clean the cover at least once a month using mild soap and water. Rinse thoroughly with fresh water to remove pollutants and soap residue. If mold/mildew staining has occurred (particularly on bottom of the cover), a mixture of bleach and water used with a soft cloth may be necessary. Thoroughly rinse with fresh water after cleaning.
- Keep cover open for 15 minutes after adding chemicals to prevent excessive off gas buildup and damage.
- When the spa is being used, the cover should be placed in a clean, dry area, otherwise it can pick up dirt and bacteria. Covers should not be put on wooden tables or wooden decking because of the risk of bleaching the wood.
- The use of a cover lift accessory or other device ensures the cover will not come into contact with the ground and retains its cleanliness (particularly the surface in close proximity to the spa water surface). The cover should be stored in an appropriate location, where it cannot be damaged, or cause damage.

**NOTE:** If your spa is going to be left empty for prolonged periods, do not place cover directly on the spa's surface (closed and sealed). Instead, place a 1" block of high density foam between the cover and the spa. This allows for ventilation to help reduce mold and mildew from occurring while the spa is empty.

**NOTE:** The cover warranty is not part of the limited warranty provided with the spa. It is provided through the cover manufacturer and may not be through Master Spas. Check the tags and labeling on your cover to verify manufacturer and refer to the manufacturer's care, maintenance and warranty information. Your dealer can help provide you with these details.

**NOTE:** Always use the water feature controls to turn down the water flow so that the water features do not hit the cover when the cover is closed. Do not turn them all the way off.

### CARE OF YOUR OZONE SYSTEM

The ozone hose and check valve connecting between the ozone generator and ozone injector should be inspected and/or replaced, if necessary, every 12 months. Depending on conditions of the air which is being brought in to the ozone generator, the ozone hose and check valve can wear more rapidly. This regular maintenance is not covered under the spa warranty. We recommend that your Master Spas Dealer or service organization be contacted to perform this type of maintenance.

## REGULAR MAINTENANCE PROCEDURES

---

▶ WATCH HOW-TO VIDEOS: [mesterspas.com/video-tutorials](https://mesterspas.com/video-tutorials)

**Note:** These maintenance procedures are the responsibility of the spa owner to perform. These procedures are not covered by the spa warranty.

### CARE OF STAINLESS STEEL

Master Spas uses stainless steel in a number of our spas. Its lasting beauty and resistance to corrosion make it an excellent material for handrails and jets faces. With the proper care it will keep its luster for many years. All stainless steel can corrode given the right circumstances so we have provided a guide to help you keep the stainless components in your spa looking nice. Stainless steel derives its ability to resist corrosion by forming a very thin transparent coating on the surface when exposed to oxygen. This coating can be damaged by abrasive materials such as steel wool, sand paper, and other cleaning materials that are abrasive. Chlorine salts, sulfides, or other rusting metals can also erode this thin coating exposing the metal to corrosion. The best defense to combat corrosion on stainless steel components in your spa is make sure that it is kept clean and free of any chemical build up.

#### **Always:**

- Clean frequently with fresh, clean water.
- Remove any rust spots as soon as they appear with vinegar or a brass, silver, or chrome cleaner.
- Use a good car cleaning wax for extra protection.
- Leave cover removed for at least 15 minutes after adding chemicals to the spa water.

#### **Never:**

- Clean with mineral acids or bleaches, steel wool or any other abrasive materials.
- Leave in contact with iron, steel any other metals.
- Close the cover immediately after adding chemicals to the water.

**NOTE:** Failure to take proper care of the stainless steel could result with them rusting. Rusting is not covered by the warranty.

**NOTE:** Do not cover the spa for 15 minutes after adding chemicals as the off gas can cause unwarranted damage. Larger dosages can require longer lengths of time to off gas. It is recommended to check spa water more frequently to allow small dosages be added as necessary versus large dosages being added less often.

# SPA TROUBLESHOOTING GUIDE

---

**NOTE:** For wiring outside of U.S. and Canada, GFCI may be referred to as a RCD (residual current device). Be sure all local electrical codes are followed.

## GFCI IS TRIPPING

A ground fault circuit interrupter (GFCI) is required by the National Electrical Code for your protection. The tripping of the GFCI may be caused by a component on the spa or by an electrical problem. Electrical problems include but are not limited to, a faulty GFCI breaker, spa component, power fluctuations, and/or improper wiring. If this is a new electrical service and GFCI installation, an instantly tripping GFCI may likely be caused by improper wiring of the load neutral from the GFCI to the spa. It may be necessary to contact an electrician if your Master Spas dealer recommends doing so.

## NOTHING ON THE SPA OPERATES

1. Check the control panel display for any messages. If there is a message, refer to the diagnostic section on that spa model. There you will find the meaning of the message and what action is to be taken.
2. If there is no message on the control panel and the control panel is completely dark (off), try to reset the GFCI breaker.



*The GFCI should be located in a weather proof box close to the spa, but no closer than 5 ft.*

If the spa does not respond, or the GFCI breaker continues to trip, contact your Master Spas dealer or service organization.

## SPA NOT HEATING

If the spas heater has failed, the majority of the time it will trip the GFCI breaker. If the spa is not heating and has not tripped the breaker, please follow these steps:

1. Check set water temperature at control panel to make sure it is set to desired temperature, above the current water temperature.
2. Check the “Heat Mode” that the spa is set in. The spa should be set in the Standard Mode or Ready Mode depending on the model. If placed in an Economy or Rest type mode, it changes the way the system heats and will primarily only heat during user programmed durations. See Spa Control section for further details.
3. Check the control panel for heat indicator. If heat indicator is on, wait a reasonable amount of time (at least 1 hour for 240V systems or 3-4 hours for 120V systems) to see if the water temperature is rising.
4. If heat indicator does not remain on, the system should be displaying a message indicating why it can't heat. Check the control panel for diagnostic messages. Refer to Spa Control Section titled System Related Messages. Follow steps to alleviate the message.
5. Check the control panel for light indicator. If the heat indicator is on, wait a reasonable amount of time (at least 1 hour for 240V systems or 3-4 hours for 120V systems) to see if the water temperature is rising.
6. Reset power to the spa at GFCI breaker.
7. If spa is still not heating, contact your Master Spas dealer or service organization.

# SPA TROUBLESHOOTING GUIDE

---

## WATER TEMPERATURE IS ABOVE SET TEMPERATURE (HEAT CREEP)

Because Master Spas hot tubs are well insulated and built to meet stringent energy standards, heat creep can occur. This means that the measured temperature of the water in your spa is creeping up higher than the set temperature on your control panel. Heat creep can occur as outdoor temperatures become moderate to warm or when your filter cycle durations have been adjusted above the default settings. To help manage heat creep:

1. **Vent your cover.** This means placing a folded cloth about  $\frac{3}{4}$  inches (2 cm) thick under all four corners of the cover before you lock the cover down.
2. **Open your cover.** Opening the cover at night will also quickly cool the water down if desired. **NOTE:** Never leave a spa cover open and unsupervised.
3. **Open all air controls.** Temporarily leave the air controls open during cooler times of the day or night. Set your filtration cycles to run during this time as well.  
**NOTE:** If the heat creep issue has been resolved, close the air controls when not using the spa to reduce energy and chemical maintenance.
4. **Reduce the length of your filter cycles.** The default duration is generally 4 hours of filtering per day (either a duration of 2 hours that occurs twice per day or one 4-hour filter duration based on time of day).
5. **Visit your local Master Spas dealer for additional guidance.** Heat creep can happen on well-insulated hot tubs, and is related to the environment where the spa is installed and equipment runtimes such as extended filter cycle durations (especially on systems using Therapy Pump 1 low speed for filtering and heating). This is not indicative that there is a problem with the spa.

## PUMP(S) DO NOT OPERATE

1. Press the “Jets” button on your control panel.

If you hear the pumps trying to operate:

- A. Check that all the slice valves are open.
- B. Pump may be air locked and needs to be primed.

Refer to Installation Instructions section. If you do not hear anything from the pump, contact your Master Spas dealer or service organization.

**NOTE:** If the pump(s) had been operating for 15 minutes or longer prior to ceasing operation, it may be normal and simply related to mild or warmer temperature conditions and excessive internal temperatures occurring from prolonged pump run-times. The spas are built to meet stringent energy efficiency standards and to run at full capacity during the 15 minute safety timeout periods. Operating pumps at high speed repeatedly beyond the 15 minute timeout can result in the pump motor getting too warm and shutting itself off to cool down. This would be seen by the control indicating the pump should be on still, but the pump has shut itself off internally. If this thermal cutout occurs, the pump will remain off for several minutes to cool. Once the equipment area and motor cool down, it would begin operating again.

## POOR JET PERFORMANCE

1. Make sure pump is operating.
2. Check that the water level is adequate (up to minimum safe water level on sticker located near filter).
3. Make sure the jets are open and the air controls are open. Refer to Glossary of Spa Technology section.



# WINTERIZING & STORING YOUR SPA

---

## WINTERIZING YOUR SPA

Your spa is designed to be used year round in any type of climate.

However, if you decide you don't want to use your spa in the winter, you must drain it and follow the winterizing steps listed below.\*

**DISCLAIMER:** Master Spas does not recommend winterizing your spa. If you choose to do so, any damage that may result is not covered under the spa warranty.

1. Drain your spa completely using the drain valve (if so equipped) or use an inexpensive submersible pump that you can buy from your local hardware store.
2. Use a shop vac to get all standing water out of your unit.
3. Remove access panels from equipment area.
4. Loosen all pump unions.
5. Remove winterizing plug from face of the pump(s) where applicable.
6. Using your shop vac in a blowing mode, insert the hose into the nozzle of each jet and blow the trapped water from the lines into the interior of the spa. A non-toxic, RV water line type antifreeze can be used and added to jets in each seat around your spa to help prevent freeze damage from occurring. Be sure to thoroughly flush the system before startup.
7. After this is completed, use the shop vac to remove any standing water in the spa and in the equipment area.
8. Clean the spa with a soft cloth and a non-abrasive spa surface cleaner.
9. Replace access panels.
10. Cover the spa to prevent water from entering it and check the spa periodically to be sure no water is entering and accumulating. Spa covers are a great insulator but will allow some precipitation to enter the spa. For this reason, it is highly advised to also cover the spa with a water tight tarp while winterized. It is beneficial to keep the spa cover slightly gapped off the acrylic shell while winterized to allow air flow in to the shell area to reduce mildew/mold buildup caused by trapped moisture.

\* If you decide to winterize your spa, we recommend that you periodically check the spa throughout the winter to assure water is not entering the spa through or around the spa cover.

## STORING YOUR SPA

The spa shell should never be left unprotected and uninsulated while being stored. Clear plastic wrap or similar material should never be used to cover/protect the spa.

Prolonged, direct sun heat can damage the surfaces of the spa along with any components on the spa's surface. Always keep the spa covered and protected with an insulating spa cover. Resulting damage such as cracking in the shell surface, warping or discolored components on the spa would not be warranted.

An empty spa should never be exposed to temperatures below 0°F (-18°C) after delivery as extreme cold can cause shell damage. This includes storage and draining (winterizing). If your spa will be exposed to these temperatures, keep the unit filled and running. If you do not plan to use your spa, you can set the spa to the lowest temperature setting allowed by the control system while in Standard/Ready Mode.

Failure to adhere to these guidelines may result in unwarranted damage caused to the spa.

# MODEL SPECIFICATIONS

MODEL	LISTING NUMBER	SPA DIMENSIONS (in./cm)	ELECTRICAL REQUIREMENTS <sup>1</sup>	SEATING CAPACITY <sup>2</sup>	WATER CAPACITY <sup>3</sup> (gallons/m)	DRY WEIGHT <sup>4</sup> (lbs./kilos)	FULL WEIGHT <sup>4</sup> (lbs./kilos)	THERAPY PUMPS	SPA SYSTEM/CONTROL	WARRANTY
INT EVO CYCLONE (INT LEGEND 4) / INT ES 632	9947 / 9948	78" x 78" x 34" / 199 x 199 x 87	*240V, 13A / 240V, 32A	5	275 / 1.04	775 / 352	3995 / 1812	1	MS6013XE / 2KW/Icon Spa Touch	Acrylic Spa / INT Models
INT EVO HURRICANE (INT LEGEND 6) / INT ES 740	9911 / 9931	84" x 84" x 36" / 214 x 214 x 92	*240V, 13A / 240V, 32A	6	315 / 1.19	880 / 399	4620 / 2096	1	MS6013XE / 2KW/Icon Spa Touch	Acrylic Spa / INT Models
INT EVO TORNADO (INT LEGEND 7) / INT ES 748	9909 / 9919	84" x 84" x 36" / 214 x 214 x 92	*240V, 32A / 3x 240V, 16A	6	320 / 1.21	925 / 420	4705 / 2134	2	MS6013XE / Icon Spa Touch	Acrylic Spa / INT Models

<sup>1</sup>See Electrical Requirements section for further details.

<sup>2</sup>Total bather capacity in spa. The number of bathers in spa should never exceed indicated seating capacity. Depending on spa size, water level and bather displacement, full seating capacity may not be achievable. Do not allow additional bathers to enter if bather displacement results in water levels overflowing or reaching the spa controls (air controls, diverters, spa topside control and etc.) as this will result in water leaking out of the spa shell and potentially in to the equipment area.

<sup>3</sup>Full weight based on dry weight of spa, max seating capacity of spa, assumed average weight per person of 185 pounds and estimated water weight of 8.34 pounds per gallon. Rounded up in increments of 5.

<sup>4</sup>Manufacturing tolerances along with other factors can result in variance in actual spa weight. If weight is a critical figure necessary for delivery, or final installation, we suggest a minimum of 15% be added to the listed weight when planning delivery or installation.

\*Default Minimum Electrical Requirement as Configured from Manufacturing. See Electrical Requirements Section For Electrical Hook-Up by Control System.

Portable spa installation is simple when properly planned. It is important that you read the following information carefully and consult with your Master Spas dealer.

- 1. ACCESS:** The actual dimensions of your new spa will determine the amount of space that is needed in moving the spa from curbside to its final installation area. Be sure to consider and measure side yard dimensions, gates, doors, overall room dimensions and vertical obstructions such as ceilings, roof overhangs, balconies and overhead cables. Any other space limiting obstacles such as stairs, trees, and shrubs must also be evaluated. Consideration should also be taken to ensure there is convenient water supply for filling your spa (review national and local regulations). The desired location for spa might require use of a crane. Please be sure to contact and review these site and installation plans with your Master Spas dealer prior to delivery. It is also good to consider these access requirements for ease of removing the spa from the premises in the event it is necessary to do so.
- 2. SURFACE/PAD REQUIREMENTS:** When your new spa is filled with water and bathers, it may weigh as much as several tons. It is imperative that the base beneath the spa can support the entire weight. The spa must be on a uniformly firm, continuous, and level surface. The recommended foundation is a concrete pad with a minimum thickness of four inches with steel reinforcement bars crossed throughout the pad.

## IMPORTANT

Consult experts and/or local authorities to review and comply with all local and national laws and regulations relating to childproofing, safety barriers, lighting and any other safety requirements at site. When installing your spa indoors, on a wood deck, roof or balcony, load requirements need to be evaluated before installation. It is also good to consider location and position of spa as well as surfaces and foundation to minimize noise disturbance as much as possible. You should speak with a qualified contractor or your local building department to confirm that your surface is adequate for supporting the spa and conforms to these guidelines.

All sides of the spa must be accessible for regular maintenance or in the event that service is needed. Periodical maintenance checks require entry into the equipment bay. When possible, it is wise planning for the future to leave 3 feet of access to all sides of the spa in the event your spa requires maintenance. Your spa warranty does not cover the cost of providing access for service.

## GENERAL CONSIDERATIONS FOR OUTDOOR INSTALLATION

Again, proper planning will increase your total enjoyment factor with your new spa. Listed below are some additional items to consider when planning your installation.

- Local building codes (if applicable)
- Power cable
- Appropriate materials and drainage around the spa to handle water presence and runoff
- Consider local environmental conditions, such as ground water and risk of frost
- In cold climates, an insulating ground cloth can be installed between foundation and spa to minimize heat loss
- How spa will complement landscaping and vice versa
- View from inside spa and view of spa from inside of home
- Exposure to sunlight and shading from trees

## SITE PREPARATION/GENERAL GUIDELINES

---

### GENERAL CONSIDERATIONS FOR INDOOR INSTALLATION

Installing your spa indoors creates an entirely different set of considerations.

- Privacy
- Getting to spa from the house and back
- Proximity to dressing rooms and bathrooms
- Storage for spa chemicals
- Work with your Master Spas dealer and contractor to insure all local building, electrical and plumbing codes are met
- Plan for proper flooring and floor drains around your spa to drain off excess water runoff that will occur during normal use and for draining and cleaning your spa
- Proper room ventilation and dehumidification
- Finished materials in your spa room should also be capable of withstanding increased humidity and moisture

### GUIDELINES FOR PARTIALLY OR FULLY RECESSED INSTALLATION

Spas manufactured by Master Spas are designed to be installed in a variety of settings. One of which is installing below grade. Should a spa be installed below the level of the site drainage system (below grade), a system for preventing water collecting and pooling must be designed based on the requirements of the local authority having jurisdiction. The drainage system must be designed based on things such as rainfall, water runoff, splashing, draining the spa, etc., that could potentially feed the below grade area with water. When located in designated floodways, additional attention to maximum water load entering the area below grade must be addressed to prevent water from accumulating below grade at all times. It is generally recommended that the spa be installed above grade because the spa is not designed to be submerged in water. When a proper drainage system is designed and proper ventilation is planned based on the characteristics of the site, installing the spa below grade is an accepted method of installation.

- The unit is self-supporting when placed on a surface designed to support the full load of the spa (see Surface/Pad Requirements). Do not backfill with sand, gravel, or earth. Doing so will void the warranty.
- Plan for complete drainage so that water accumulation drains away from the spa perimeter and standing water never reaches the electrical equipment.
- Plan for appropriate ventilation to remove moisture accumulation and to prevent equipment from overheating.
- Provide a minimum of 3 feet service area around the perimeter of the unit. Site access issues are not covered by the product warranty.
- The unit is not designed to be submerged in water. Water entering the equipment area creates many hazards and resulting damage will not be covered by the product warranty.
- Make sure that the surroundings do not create any additional hazards.
- Surfaces placed around the unit should also be evaluated for walking/slipping hazards from standing water. Proper drainage is vital to the installation of a below grade installation.
- Check all building, electrical, and plumbing codes with the authority having jurisdiction to ensure that your installation is in compliance with all local codes.
- Additional consideration needs to be made when installing unit in designed floodways.
- Verify that site specific drainage systems such as down spouts are not going to feed the area below grade.
- Below grade drainage system needs to be evaluated based on area specific rainfall. One size does not fit all so an analysis by a qualified, local engineer to ensure proper drainage of all sources of water is a must when installing below grade.

# SITE PREPARATION/GENERAL GUIDELINES

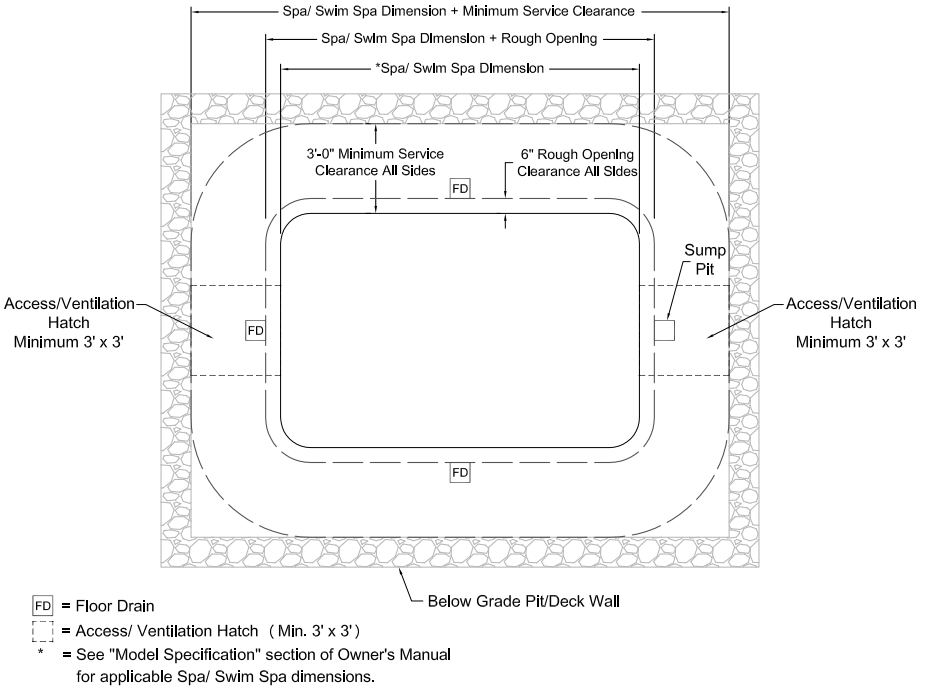

# ELECTRICAL REQUIREMENTS

## ALL MODELS

**Note:** Electrical requirements by model is shown in Model Specifications. Only electrical configurations pertaining to the models referenced in this manual are shown.

### ELECTRICAL REQUIREMENTS

#### HAVE YOUR ELECTRICIAN READ THE FOLLOWING INFORMATION BEFORE INSTALLATION BEGINS

Electrical connections made improperly, or the use of wire gauge sizes for incurring power which are too small, may continually blow fuses in the electrical equipment box, may damage the internal electrical controls and components, may be unsafe and in any case will void your warranty.

It is the responsibility of the spa owner to ensure that electrical connections are made by a qualified electrician in accordance with codes regulated by the authority having jurisdiction at the time of installation.

These connections must be made in accordance with the wiring diagrams found inside the control box and in this manual. This equipment has been designed to operate on and requires 230V, 50Hz service. Make sure that power is not applied while performing any electrical installation. A bonding lug for bonding copper wire has been provided on the electrical equipment pack to allow connection to local ground points. The ground wire must be at least 8 AWG (8.36mm<sup>2</sup> copper wire unless local or state codes require a heavier gauge wire) and must be connected securely to a grounded metal structure such as a metallic cold water pipe. Be sure to have a licensed electrician examine and ensure proper grounding is provided. See chart on next page for wire size conversion. All Master Spas equipment packs are wired for 230 VAC only. The only electrical supply for your spa must include a switch or circuit breaker to open all non-grounded supply conductors to comply with BS7671 (or other local jurisdiction code or law). The disconnect must be readily accessible to the spa occupants, but installed at least five feet from the spa. Residual Current Device (RCD) must be used to comply with this manual, BS 7671, or any local electrical code or law requirements. A residual current is a current leak from any one of the supply conductors to ground. An RCD is designed to automatically shut off power to a piece of equipment when a ground fault is detected.

Route the cable into the equipment area for final hook-up to terminals inside the control pack or junction box. The spa must be hooked up to a “dedicated” breaker(s) and RCD. The term “dedicated” means the electrical circuit for the spa is not being used for any other electrical items (patio lights, appliances, garage circuits, etc.). If the spa is connected to a non-dedicated circuit, overloading will result in “nuisance tripping” which requires resetting of the breaker switch at the house electrical panel.

202012

# ELECTRICAL REQUIREMENTS

## 230 VOLT 50 HZ – RESIDUAL CURRENT DEVICES (RCDS)

A residual current device (RCD) is the generic term for a device that monitors the current in the line conductor and the neutral conductor in an earthed system.

In a circuit that's operating properly, the vector sum of the live and neutral current values added together will be zero. Current flowing to earth, due to a line earth fault, will return via the earth conductor, and regardless of load conditions, will be registered as a fault. This current flow will give rise to a residual current that will be detected by the device. If the residual current exceeds the rated sensitivity of the RCD, it will automatically activate a tripping of the faulty circuit.



Two Pole RCD



Four Pole RCD

### Typical specifications are as follows:

Residual Current Devices (RCDs) range

Sensitivity – from 10 to 30mA

Voltage – 2 poles: 230V; 3/4 poles: 230/400V

Connection capacity

- 25A: 6/10 mm<sup>2</sup> (flexible/rigid cable)

- 40,60A: 16/25 mm<sup>2</sup>

- 80,100A: 35/50 mm<sup>2</sup>

Total Ampere Rating of Power System	Minimum Wire Size Use Copper ONLY with 90 °C Insulation	Ampere Rating of RCD Circuit-Breaker
0 A to 16 A	#12 AWG / 3.31 mm <sup>2</sup>	20
16 A to 20 A	#10 AWG / 5.26 mm <sup>2</sup>	25
20 A to 24 A	#10 AWG / 5.26 mm <sup>2</sup>	30
24 A to 28 A	#8 AWG / 8.36 mm <sup>2</sup>	35
28 A to 32 A	#8 AWG / 8.36 mm <sup>2</sup>	40

**CAUTION – Actual wiring of RCD will vary by manufacturer of RCD. Improper wiring of RCD may result in permanent damage to spa control pack. Repair/replacement of spa system box is not covered under warranty when damage results from improper wiring. Actual wire attachment points on the Spa Control Pack may vary. Always refer to the wiring diagram inside the Spa Control Pack for proper power connection.**

# ELECTRICAL REQUIREMENTS

## MS6013XE HOOK-UP

### AS MANUFACTURED – SINGLE SERVICE (Figure 1)

Single Service, TN and TT Electrical Systems (1x13 Amp, 1x16 Amp or 1x32 Amp)\* 3 Wires (1 Line + 1 Neutral + 1 Protective Earth). Protective Earth wire (Green/Yellow) must be connected to system ground terminal as marked.

Heat Disable dip switches (Switch Bank S1, A2-A4) must be evaluated to prevent the spa maximum ampacity from exceeding the service maximum ampacity. When wiring spa to electrical requirements as configured from factory, dip switch settings should not be changed from factory settings.\*

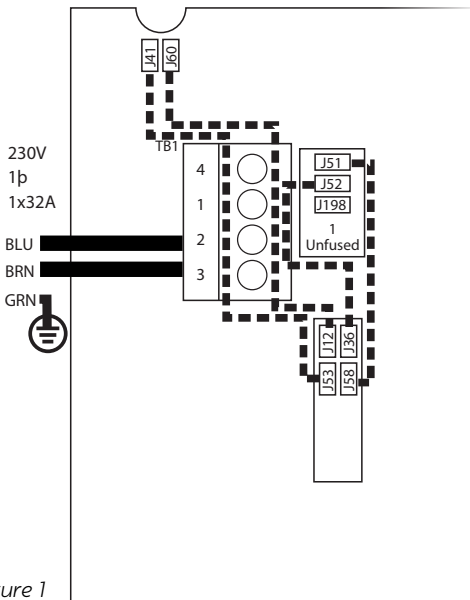

Figure 1

\*Wiring must be sized to spa specification. Spa rated maximum ampacity cannot exceed the service maximum ampacity. This does not represent an option to the Installer. See Model Specifications page for electrical requirements by spa model.

**CAUTION – RCD will vary by manufacturer of RCD. Improper wiring of RCD may result in permanent damage to spa control pack. Repair/replacement of spa system box is not covered under warranty when damage results from improper wiring. Actual wire attachment points on the Spa Control Pack may vary. Always refer to the wiring diagram inside the Spa Control Pack for proper power connection.**



# ELECTRICAL REQUIREMENTS

## MS6013XE HOOK-UP

### OPTIONAL HOOKUP – 3 SERVICE (Figure 2)

3-Phase Service, TN and TT Electrical Systems 5 Wires (3 Lines + 1 Neutral + 1 Protective Earth)\*. Protective Earth wire (Green/Yellow) must be connected to system ground terminal as marked.

1. Remove all jumper wires as indicated by dotted lines in Figure 1 (previous page).
2. Only reinstall jumper wires as indicated by dotted lines in Figure 2.

### IMPORTANT – EACH SERVICE MUST INCLUDE A NEUTRAL WIRE, WITH A LINE TO NEUTRAL VOLTAGE OF 230VAC.

Heat Disable dip switches (Switch Bank S1, A2-A4) must be evaluated to prevent the spa maximum ampacity from exceeding the service maximum ampacity per line (L1, L2 & L3).

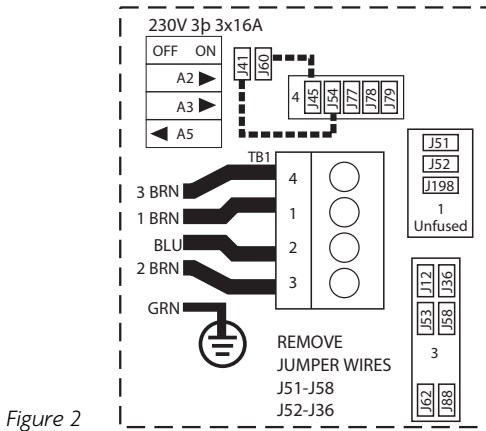

Figure 2

\*Wiring must be sized to spa specification. Spa rated maximum ampacity cannot exceed the service maximum ampacity. This does not represent an option to the Installer. See Model Specifications page for electrical requirements by spa model.

**CAUTION – RCD will vary by manufacturer of RCD. Improper wiring of RCD may result in permanent damage to spa control pack. Repair/replacement of spa system box is not covered under warranty when damage results from improper wiring. Actual wire attachment points on the Spa Control Pack may vary. Always refer to the wiring diagram inside the Spa Control Pack for proper power connection.**

▶ WATCH HOW-TO VIDEOS: [masterspas.com/video-tutorials](https://masterspas.com/video-tutorials)

## SETUP STEPS

1. Put spa in final position that allows for access to equipment and spa components. Master Spas recommends that at least 3 feet of space be provided around all sides of the spa for access. This provides adequate space for regular maintenance and service.
2. Remove front skirt panel (this is the side where the topside control panel is located) so electrical can be hooked up to the spa control system. This panel is removed by unscrewing the screws securing the skirt corners and the front skirt panel.
3. With the front skirt panels removed allowing access to the equipment, be sure all pump and heater unions are secure. Each pump has 2 unions and the heater has 2 unions. A newly delivered spa may have loose unions caused in transporting the spa. Check that all slice valves are open, in the up position. The slice valves may become closed during transportation of the spa.



*Slice Valve and Pump Union*

Fill spa to minimum water level label indication located on the spa shell near the filter area or at least 1' above the filters or filter housing opening. We recommend filling the spa through the filter area to help reduce air locks from occurring in the filter and heating pump. When filling or topping off water, do not exceed the maximum fill level indication on the water level label.

- NOTE:** In below freezing temperatures, caution should be taken when planning to install a spa and fill it with water. As it takes time for the water to fill the spa and reach the proper minimum water level, the water entering the various plumbing lines and equipment may begin to freeze up when done in winter weather conditions. This could result in pumps being seized until thawed or other potentially worse freeze damage occurring to the equipment and plumbing lines.
5. Turn the power on to the spa. Once the system and control panel loads to operational state, activate each jet pump to ensure they are not air locked before the system continues normal heating and filtering operations. See the spa controls section of this manual for additional instructions on control startup.
  6. Be sure the adjustable jets in your spa are open by turning the face of the jet. Most of the jets in your spa are adjustable and removable by turning the face of the jet.

## INITIAL SPA SETUP

---

- It may be necessary to bleed air from the pump(s) in your spa if, after start up, your spa pumps are turning on and off but you do not have water flow from the jets in your spa. Due to the nature of water flow and hydro-therapy pumps, please be advised that air locking of pumps may occur. Master Spas has taken measures to reduce the possibility of this, but it still may occur, especially after refilling a spa. This is not a service covered under warranty and service charges may apply.

To relieve an airlock situation, loosen the pump union on the discharge of the pump. This pump union is indicated by an arrow in the picture below. Water should leak out of the union once the air has been removed. Tighten the union and test the pump for proper operation. Repeat this process if needed.

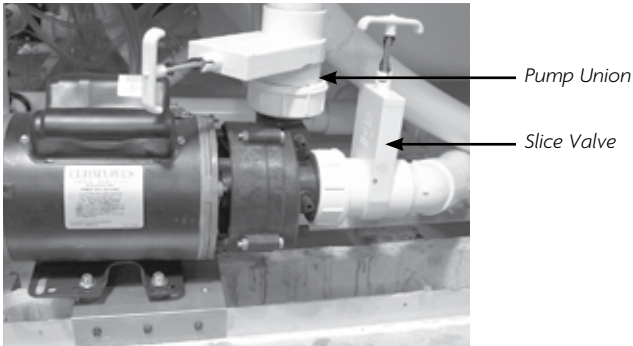

*Airlock*

- Adjust water chemistry according to the instructions provided in the Water Maintenance section.
- \*Your spa water will heat approximately 3 to 4 degrees Fahrenheit per hour (1 to 2 degrees Celsius) with the cover placed on the spa. This varies depending on the size of the spa and ambient temperatures.
- Step into the soothing waters of your Master Spa!  
**Relax and enjoy.**

\*240V systems only. 120V spa models increase at approximately 1°F per hour (can vary depending on model and temperature conditions).



**WATCH HOW-TO VIDEOS:**  
[masterspas.com/video-tutorials](http://masterspas.com/video-tutorials)

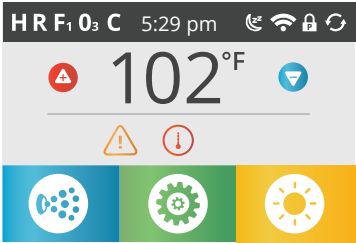

# SPA CONTROLS - ICON SPA TOUCH

## THE MAIN SCREEN

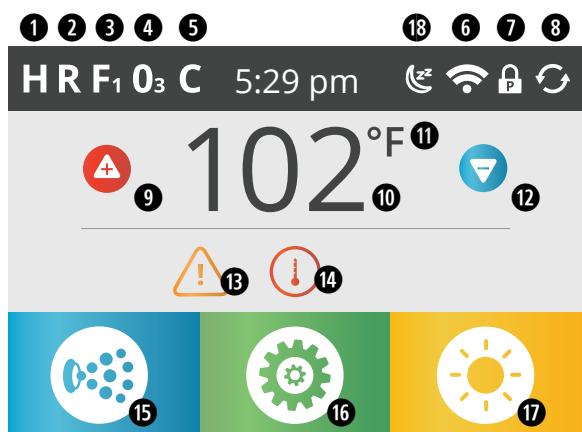

## SPA STATUS

Important information about spa operation can be seen on the Main Screen. Various features and main menus can be accessed from this screen. The actual water temperature can be seen and the Set Temperature can be adjusted. Time-of-Day, Ozone and Filter Cycle status is visible, along with other messages and alerts. The selected Temperature Range is indicated in the upper left corner. The Spa Equipment Control Icon in the bottom left corner will bubble if any pump is running. A Lock icon is visible if the panel or settings are locked.

## ICON SPECIFICATIONS

- |   |                              |
|---|------------------------------|
| ① H = High Temperature Range              | ⑩ Current Water Temperature  |
| ② R = Ready Mode                          | ⑪ Temperature Scale (F/C)    |
| ③ F <sub>1</sub> = Filter Cycle 1 Running | ⑫ Set Temperature Down       |
| ④ O <sub>3</sub> = Ozone Running          | ⑬ Message Waiting Indicator  |
| ⑤ C = Cleanup Cycle                       | ⑭ Heat Indicator             |
| ⑥ Wi-Fi Indicator                         | ⑮ Spa Equipment Control Icon |
| ⑦ Lock Indicator Icon                     | ⑯ Settings Icon              |
| ⑧ Invert Screen                           | ⑰ Light Icon = Turns On/Off  |
| ⑨ Set Temperature Up                      | ⑱ Instant Sleep Mode         |

**NOTE:** After 30 minutes the display will automatically go into sleep mode, which turns the display off. This is normal operation. Touch anywhere on the screen to wake the control panel up.



# SPA CONTROLS - ICON SPA TOUCH

---



## THE MAIN SCREEN

### ICON SPECIFICATIONS

1. **H** = HIGH TEMPERATURE RANGE **L** = LOW TEMPERATURE RANGE
2. **R** = READY MODE **R<sup>2</sup>** = READY AND REST MODE **R<sup>2</sup>** = REST MODE
3. **F<sub>1</sub>** = FILTER 1 MODE **F<sub>2</sub>** = FILTER 2 MODE **F<sub>+</sub>** = FILTER 1 AND 2 MODE
4. **O<sub>3</sub>** = OZONE IS RUNNING If you don't see the icon that means the Ozone is OFF.
5. **C** = CLEANUP CYCLE IS RUNNING: If you don't see the icon that means the Cleanup Cycle is OFF.
6. **Wi-Fi** = WI-FI ICON just indicates that the optional Wi-Fi module is connected to the spa system. It does not indicate signal strength.
7. **LOCK ICON**: When displayed, indicates the panel is in a locked mode.

There are 2 lock icons that can be shown on the title bar of most screens. A lock icon with an 'S'  means that a settings lock has been applied. It is shown on screens that are affected by the settings lock. And a lock icon with a 'P'  means the Panel has been locked. If both settings and panel are locked, only the panel lock will show since it overrules just settings being restricted. When the panel is locked, the Settings Menu Screen will only show items not affected by that lock (System Info and Lock Screens).

To unlock or lock a setting or panel lock, you press the corresponding icon that is locked and then press and hold the word "Lock" in the title bar for 5+ seconds until the text and icon change to the opposite state.

8.  = INVERT (OR FLIP) SCREEN
9.  = SET TEMPERATURE UP: Adjust set temperature higher.
10. **CURRENT WATER TEMPERATURE**: Displays current water temperature.
11. **TEMPERATURE SCALE**: Indicates if the temperature is in **°F** = FAHRENHEIT OR **°C** = CELSIUS
12.  = SET TEMPERATURE DOWN. Adjust set temperature lower.
13. **MESSAGE WAITING INDICATOR**. The Message Waiting Indicator will show one of the following icons:

 = CRITICAL ERROR (Spa can't function until it's fixed)

 = NORMAL ERROR OR WARNING

 = REMINDER MESSAGE

 = INFORMATION MESSAGE

Touch the Indicator to go to a Message Screen which shows the message.

Some messages will include the "Call for Service" text as it requires a service technician to fix the problem. If the panel is locked and a message alert appears, you will be taken to the UNLOCK screen before you can clear the message.







Touching the Error/Warning/Reminder/Info Icon on the Message Screen will take you to the System Information Screen to allow for troubleshooting over the phone or for a field service tech to better understand what is going on. Exiting the System information Screen will take you back to the Message Screen in that situation.

# SPA CONTROLS - ICON SPA TOUCH

## THE MAIN SCREEN

14.  = **HEAT INDICATOR**. Indicates the heating process and when the spa heater is on.

## ICON SPECIFICATIONS

15.  = **SPA EQUIPMENT CONTROL ICON**. Brings up a screen where the spa jets or other equipment can be controlled. While on the Spa Equipment Screen, you can press a Jets button once for low speed, and if applicable, press it again for high speed.
16. **SETTING ICON:**  = **SETTINGS IS ACTIVE**  = **SETTINGS IS INACTIVE**  
Takes you to Settings Menu Screen, where the available specific features that can be adjusted by the control panel can be modified.
17.  = **LIGHT IS TURNED ON**  = **LIGHT IS TURNED OFF**  = **LIGHT IS DISABLED**
18.  = **INSTANT SLEEP MODE ICON**: This is to force the screen to sleep immediately versus letting it time out after a few minutes. This can be used to help prevent splashing and water on the screen from causing undesired input on the touch panel.

## NAVIGATION

Navigating the entire menu structure is done by touching the screen.

The screen selections indicated below can be selected to take you to additional menus. Touch one of these to enter a different screen with additional controls.

Most menu screens time out and revert to the main screen after 30 seconds of no activity.

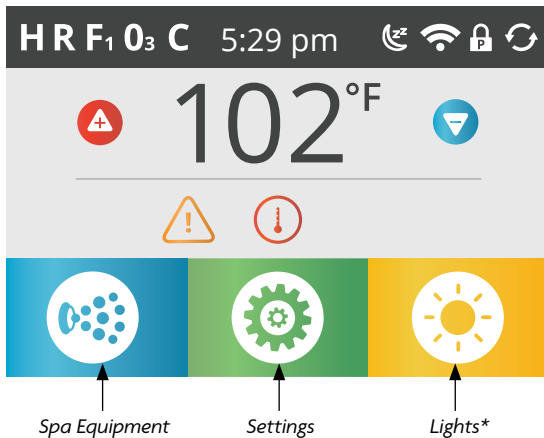

*\*Only if Light System is equipped.  
Options vary by model.*

# SPA CONTROLS - ICON SPA TOUCH

## THE MAIN SCREEN

### MESSAGES

At the bottom of the screen, at certain times an indicator may appear showing that a message is waiting. Touch this indicator to go to the Message Display Screen. On that Screen some of the messages can be dismissed.

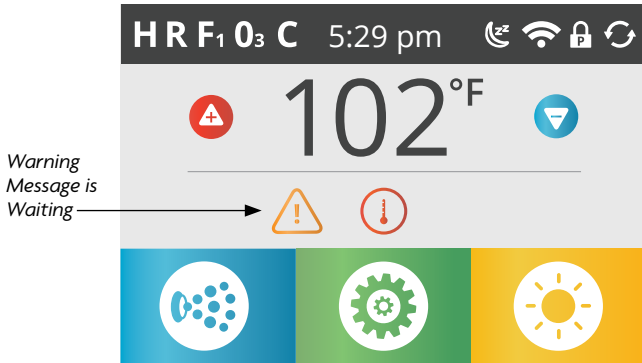

### SLEEP

The topside control panels have a sleep function, so it is not always on. This can be utilized through the instant sleep mode, or it will activate once the specified time limit has been reached. When operating the panel after it has gone to sleep, you will need to tap first a 1 and then a 2 as they appear on the left and right of the lower portion of the spa screen. The amount of time before the topside control panel goes to sleep can be adjusted in the utilities section of the settings menu.



# SPA CONTROLS - ICON SPA TOUCH

## THE SET TEMPERATURE AND LIGHTS

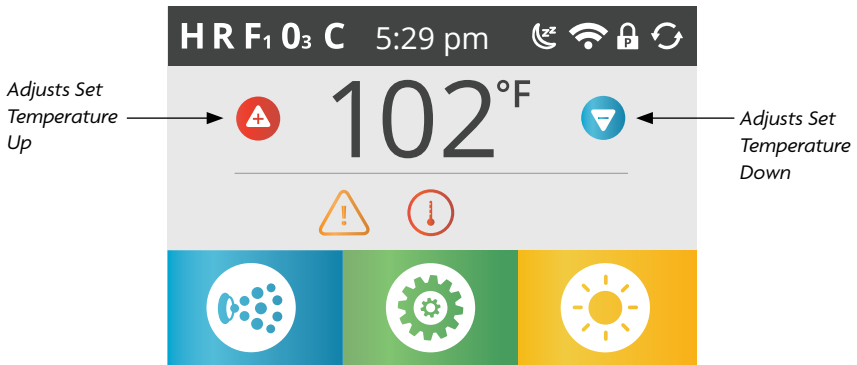

### SET TEMPERATURE

Press Up or Down once to display the Set Temperature (indicated by a flashing °F or °C). Press Up or Down again to modify the Set Temperature. The Set Temperature changes immediately.

If you need to switch between High Temperature Range and Low Temperature Range you need to go to the Settings Screen.

### PRESS-AND-HOLD

If Up or Down is pressed and held, the temperature will continue to change until you stop pressing, or until the Temperature Range limits are reached.

### LIGHTS

The Lights Icon  turns the lights (if equipped) inside your spa on or off. If your spa is equipped with LED Light System, turn the lights on and off repeatedly within a couple of seconds to rotate through available color schemes.

# SPA CONTROLS - ICON SPA TOUCH

## THE SPA SCREEN

### ALL EQUIPMENT ACCESS

The Spa Equipment Icon  takes you to the Spa Screen, which shows all available equipment\* to control. The display shows icons that are related to the equipment installed on a particular spa model, so this screen may change depending on the installation.

The icon buttons are used to select and control individual devices.

Some devices, like pumps, may have more than one ON state, so the icon will change to reflect the state of the equipment. Below are some examples of 2-speed Pump indicators.



If the spa has a Circulation Pump, a Circulation Pump Icon will appear to indicate its activity, but outside of Priming Mode, the Circulation Pump cannot be controlled directly.

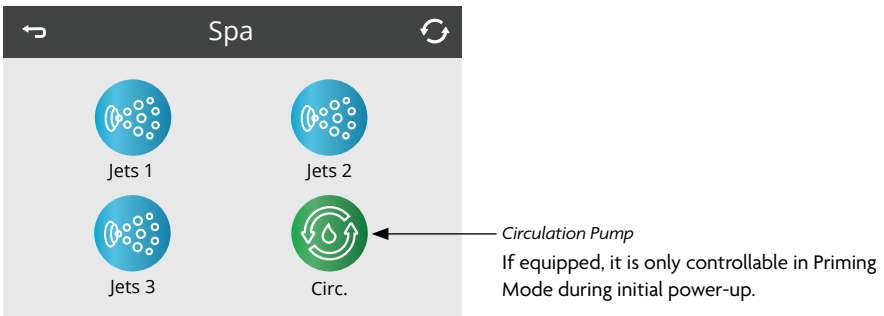

*\*One exception: The Main Spa Light is not shown on the Spa Screen; it is only shown (and controlled) on the Main Screen.*

# SPA CONTROLS - ICON SPA TOUCH

## COMMON BUTTONS

### VALUES INCREMENT/DECREMENT

If an Up or Down button is shown and pressed when on an editing page, and a value has been selected (highlighted), the value can be increased by pressing the Up Arrow or decreased by pressing the Down Arrow.

### INVERT

Will appear on upper right on all screens.

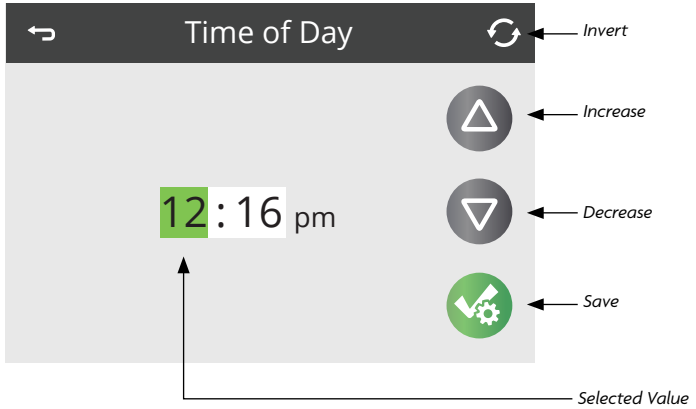

# SPA CONTROLS - ICON SPA TOUCH

## COMMON BUTTONS

### EXITING SCREENS

The Back button is on every screen except the Main Screen, the Priming Mode Screen and Message Display Screen.

When you see only this button, or this button plus an Inactive Save Button, it means Back or Exit. It appears on editing screens before you have changed any value, as well as on all other screens.

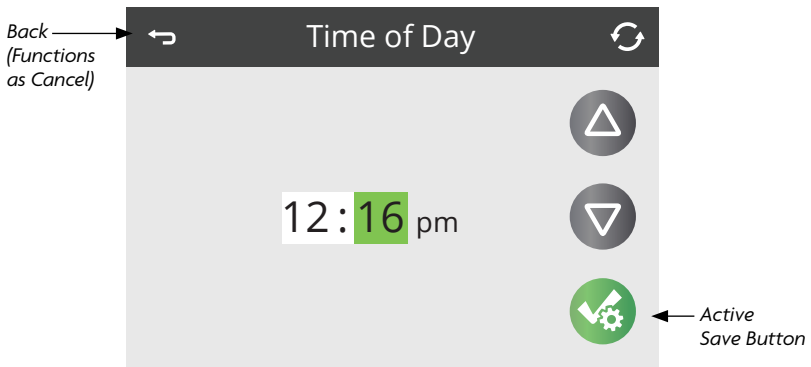
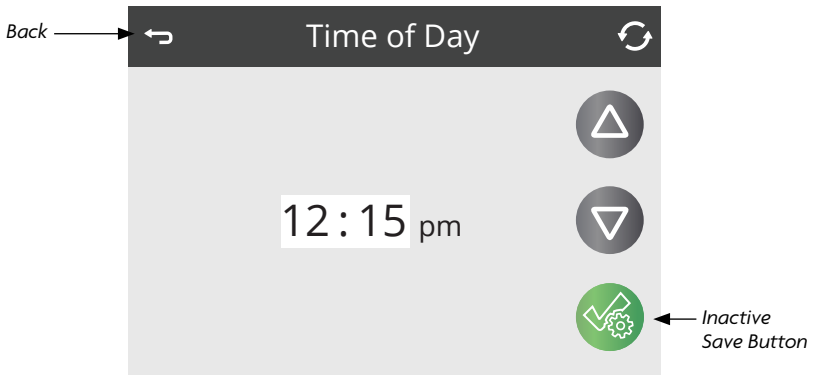

When you see both the Back button and an Active Save button, the Save button will Save, turning the green selection to white, while the Back button will Cancel. If the screen times out due to no activity it will act like Cancel.

# SPA CONTROLS - ICON SPA TOUCH

## COMMON BUTTONS

### PAGE RIGHT/LEFT

If there is a Right Arrow at the bottom of the screen, it takes you to the next page.

If there is a Left Arrow at the bottom of the screen, it takes you to the previous page.

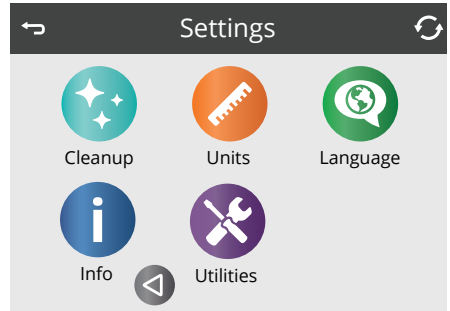

### PAGE UP/DOWN

If an Up or Down button is shown and pressed when on a page with a text list, the list can be scrolled a page at a time.

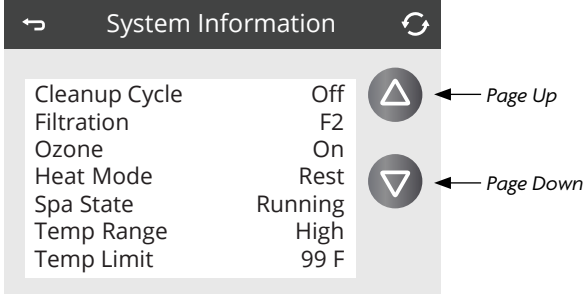

# SPA CONTROLS - ICON SPA TOUCH

## THE SETTINGS SCREEN

### PROGRAMMING, ETC.

The Settings Icon  takes you to the Settings Screen, where all programming and other spa behaviors are controlled.

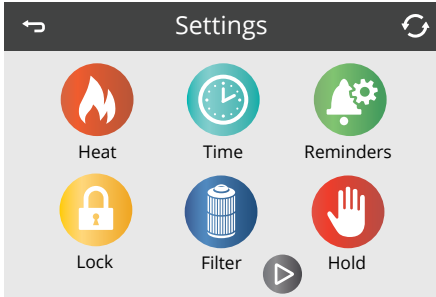

Each icon on the Settings screen takes you to a different screen, where one or more settings may be viewed and/or edited.

### HEAT MENU

The Heat Icon  in the Settings Screen takes you to a screen where you can control the Heat Mode and the Temperature Range.

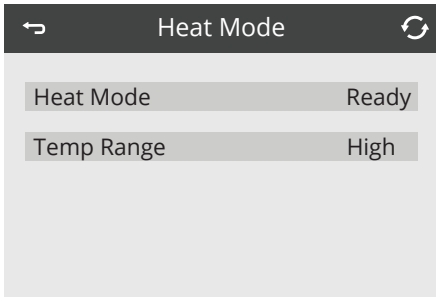

### TEMPERATURE RANGES (HIGH VS. LOW)

This system incorporates two temperature range settings with independent set temperatures. The specific range can be selected on the Settings Screen and is visible on the Main Screen in the upper left corner of the display.

These ranges can be used for various reasons, with a common use being a “ready to use” setting vs. a “vacation” setting. Each range maintains its own set temperature as programmed by the user. This way, when a range is chosen, the spa will heat to the set temperature associated with that range. Check the set water temperature and consider lowering it for the times when the spa will typically not be in use.

High Range can be set between 80°F (27°C) and 104°F (40°C). Low Range can be set between 50°F (10°C) and 99°F (37°C). Freeze Protection is active in either range. Consider that the comfortable temperature range during use may be lower than the maximum safe temperature.

# SPA CONTROLS - ICON SPA TOUCH

## THE SETTINGS SCREEN

### HEAT MODE – READY VS. REST

In order for the spa to heat and check temperature, a pump needs to circulate water through the heater. The pump that performs this function is known as the “heater pump”. The heater pump can be either a 2-speed Pump (Pump 1) or a Circulation Pump.

### READY MODE

If the heater pump is a 2-speed Pump 1, Ready Mode will circulate water every 1/2 hour, using Pump 1 Low, in order to maintain a constant water temperature, heat as needed, and refresh the temperature display. This is known as “polling”.

### REST MODE

If the spa is not going to be used for a prolonged period of time, this mode will only allow heating during programmed filter cycles. Since polling does not occur, the temperature display may not show a current temperature until the heater pump has been running for a minute or two. This is seen on the screen as: \_ \_ \_ \_ °F    \_ \_ \_ \_ °C. Using Rest Mode is not recommended in below freezing temperatures.

### READY-IN-REST MODE

Ready in Rest Mode appears in the display if the spa is in Rest Mode and the Jets 1 Button is pressed. When the heater pump has come on automatically (for example for heating) you can switch between low speed and high speed but you cannot turn the heater pump off. After 1 hour, the System will revert to Rest Mode. This mode can also be reset by selecting the Heat Mode.

### M8 SMART TEMPERATURE MONITORING

As a default, the M8 Icon  is set as ON/Active. M8 affects the spa operation behavior for non-circulation pump systems which use therapy Pump 1 (Jets 1) low speed for monitoring spa water temperature, heating and filtering. If your spa has a dedicated circulation pump system such as Quietflo or Mast3rPur, these behaviors do not apply.



ON/ACTIVE    OFF/INACTIVE

While ON/Active and the spa system set to Ready Heat Mode, M8 can actively change Pump 1 low speed water temperature polling intervals from every 30 minutes to become less frequent, up to 2 hours in between polling points, if the spa water temperature is remaining very stable.

The screen will show: \_ \_ \_ \_ °F    \_ \_ \_ \_ °C any time the polling interval extends beyond 30 minutes. This indicates the spa does not know what the exact water temperature is. To see the current water temperature, activate Pump 1, so the system can check the temperature.

If set to OFF/Inactive and the spa system set to Ready Heat Mode, the spa control system will only poll to check current spa water temperature every 30 minutes.

# SPA CONTROLS - ICON SPA TOUCH

## FILL IT UP!

### PREPARATION AND FILLING

Fill the spa to its correct operating level, using the instructions found in Initial Spa Setup under the Installation Instructions section.

#### PRIMING MODE – M019\*

After the initial start-up sequence, the control will enter Priming Mode and display a Priming Mode screen. Only pump icons appear on the priming mode screen. During the priming mode, the heater is disabled to allow the priming process to be completed without the possibility of energizing the heater under low-flow or no-flow conditions. Nothing comes on automatically, but the pump(s) can be energized by selecting the “Jet” buttons. If the spa has a Circulation Pump, it can be turned on and off by pressing the “Circ” button during Priming Mode.

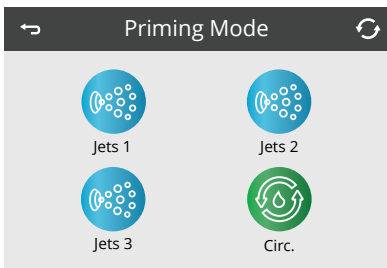

#### PRIMING THE PUMPS

As soon as the Priming Mode screen appears on the panel, select the “Jets 1” button once to start Pump 1 in low-speed (if applicable) and then again to switch to high-speed. If the pump is operating but there is no water flow after 10 seconds of running, shut the pump off for 5-10 seconds and then back on for 5-10 seconds. Repeat until water begins flowing, this means the pump is primed. Also select the other pumps to turn them on and perform this priming process if necessary. If the

pumps have not primed after 4-5 minutes, and water is not flowing from the jets in the spa, do not allow the pumps to continue to run. Turn the spa off, then back on and repeat the process.

**NOTE:** Turning the power off and back on again will initiate a new pump priming session. Do not do this more than 5 times. If the pump(s) will not prime, shut off the power to the spa and see instructions for relieving an air lock in the Initial Spa Setup section.

**IMPORTANT:** A pump should not be allowed to run continuously without priming for more than 2 minutes. Under NO circumstances should a pump be allowed to run without priming beyond the end of the 4-5 minute priming mode. Doing so may cause damage to the pump and cause the system to energize the heater and go into an overheat condition.

#### EXITING PRIMING MODE

The system will automatically enter the normal heating and filtering at the end of the priming mode, which lasts 4-5 minutes. You can manually exit Priming Mode by pressing the “Back” button on the Priming Mode Screen. Note that if you do not manually exit the priming mode as described above, the priming mode will be automatically terminated after 4-5 minutes. Be sure that the pump(s) have been primed by this time. Once the system has exited Priming Mode, the top-side panel will display the Main Screen, but the display will not show the water temperature yet, as shown below. This is because the system requires approximately 1 minute of water flowing through the heater to determine the water temperature and display it. The panel will display the following until it is able to get a temperature read: \_ \_ \_ \_ °F \_ \_ \_ \_ °C

\*M0XX is a Message Code. See Messages Log in the Utilities section.



# SPA CONTROLS - ICON SPA TOUCH

---

## SPA BEHAVIOR

### PUMPS

On the Spa Screen, select a “Jets” button once to turn the pump on or off, and to shift between low- and high-speeds if equipped. If left running, the pump will turn off after a time-out period (15 minutes at high speed).

### NON-CIRCULATION SYSTEMS

To monitor current water temperature, the system will automatically activate Pump 1 at the low-speed setting as needed. If the spa is in Ready Mode, Pump 1 low may activate for at least 1 minute every 30 minutes to monitor the spa water temperature (known as polling) and begin to heat if water temperature has dropped below the set temperature. If the water temperature remains consistent over long periods, and does not decrease, the M8 technology in your spa will actively adapt these polling intervals to be less frequent. If the water temperature conditions are very stable, M8 will gradually increase time between the intervals, up to 2 hours. If the water temperature starts dropping significantly, the system will check the water temperature (poll) more frequently, reverting the interval back to every 30 minutes. It will also reset the intervals back to 30 minutes whenever the user interacts with the system (such as activating equipment, changing heating modes and modifying the set temperature).

Pump 1 runs automatically, at the low-speed setting, when any other pump is turned on (if equipped) so that the system can monitor the spa water temperature.

When the low-speed of Pump 1 turns on automatically for either temperature polling, heating or filter cycles, it cannot be turned off at the control panel. However, the high speed setting on the pump can be turned on.

### CIRCULATION PUMP MODES

If the system is equipped with a circulation pump, it will be configured to work in one of two different ways depending on the control system software. The circulation pump mode cannot be changed.

1. Most circulation pumps operate continuously (24 hours) with the exception of turning off for 30 minutes at a time when the water temperature reaches 3°F (1.5°C) above the set temperature (most likely to happen in warm climates or if set temperature is lowered/set below the current water temperature). This is the typical mode for most spas with a dedicated circulation pump.
2. A programmable circulation pump will come on when the system is checking temperature (polling), during filter cycles, during freeze conditions, or when another pump is on.

### FILTRATION AND OZONE

On non-circulation systems, Pump 1 low and the ozone generator will run during filtration. On circulation systems, the ozone will generally run with the circulation pump.

The system is factory-programmed with one filter cycle that will run in the evening (assuming the time-of-day is properly set) when energy rates are often lower. The filter time and duration are programmable. A second filter cycle can be enabled as needed.

At the start of each filter cycle, the pumps will run briefly to purge the plumbing to maintain good water quality.

See Adjusting Filtration section within Spa Controls for more information.

# SPA CONTROLS - ICON SPA TOUCH

---

## SPA BEHAVIOR

### **FREEZE PROTECTION**

If the temperature sensors within the heater detect a low enough temperature, then the pumps automatically activate to provide freeze protection. The pumps will run either continuously or periodically depending on conditions.

### **CLEAN-UP CYCLE (OPTIONAL)**

When a pump is turned on by a button press, a clean-up cycle begins 30 minutes after the pump is turned off or times out. The heat/filter pump and the ozone generator will run for 30 minutes or more, depending on the system. If the spa has a 24hr circulation pump which performs as the heat and filter pump, the cleanup cycle will not apply as the 24hr circulation pump provides constant filtration. On some systems, you can change this setting. See the Cleanup Cycle section in Additional Settings.

# SPA CONTROLS - ICON SPA TOUCH

## TIME-OF-DAY

### SETTING THE TIME-OF-DAY

Be sure to set the time-of-day, it is important for determining filtration times and other background features.

The Time Icon  on the Settings Screen takes you to a screen where you control the Time-of-Day. On the Time-of-Day screen, use the Up and Down Buttons to make changes to the highlighted green field. You can toggle between hours and minutes to make changes by touching the numbers on the screen. When finished, Save and the green field will turn white.

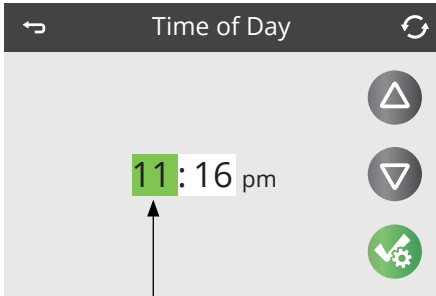

*Green highlight shows an active field to edit*

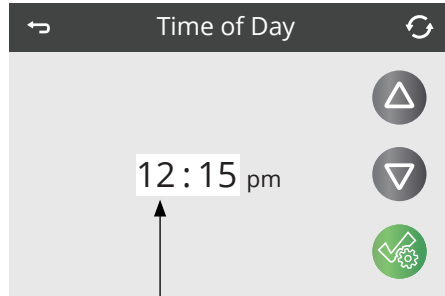

*Field changes to white when saved*

If no time-of-day is set in the memory an Information Screen will appear. If you exit it an Information Icon will appear at the bottom of the Main Screen, until the time-of-day has been set.

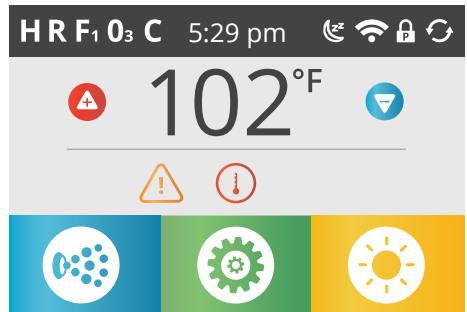

# SPA CONTROLS - ICON SPA TOUCH

## ADJUSTING FILTRATION

### MAIN FILTRATION

Using similar adjustments as the Time-of-Day Screen on previous page, Filter Cycles are set using a start time and an end time. Each setting can be adjusted in 15-minute increments. The panel calculates the duration and displays it automatically.

The Filter Icon  on the Settings Screen takes you to a screen where you control the Filter Cycles.

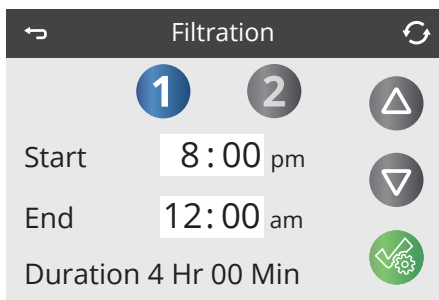

### FILTER CYCLE 2 - OPTIONAL FILTRATION

Filter Cycle 2 is OFF by default on most systems. Press "1" to view Filter 1. Press "2" once to view Filter 2. Press "2" again to turn Filter 2 ON or OFF.

When Filter Cycle 2 is ON, it can be adjusted in the same manner as Filter Cycle 1.

It is possible to overlap Filter Cycle 1 and Filter Cycle 2, which will shorten overall filtration by the overlap amount.

**Viewing Filter 1 while Filter 2 is OFF:**

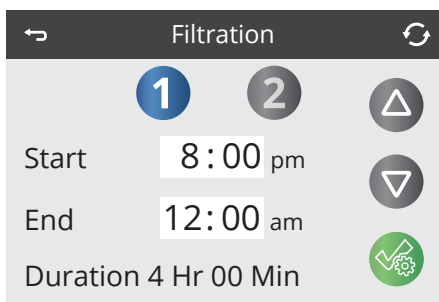

**Viewing Filter 2 when it is ON and selected:**

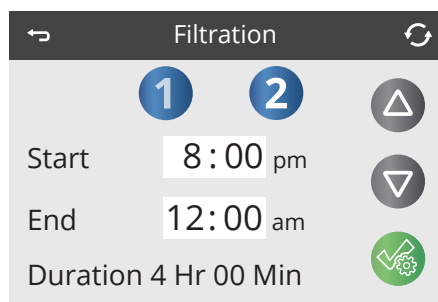

# SPA CONTROLS - ICON SPA TOUCH

---

## ADJUSTING FILTRATION

### PURGE CYCLES

In order to maintain sanitary conditions, as well as protect against freezing, all pumps will purge water from their respective plumbing by running briefly at the beginning of each filter cycle. It is best that all jets be left in their open position and water diverters in their centered positions when done using the spa so all jets get water flow during purge cycles.

If the Filter Cycle 1 duration is set for 24 hours, enabling Filter Cycle 2 will initiate a purge when Filter Cycle 2 is programmed to begin.

### THE MEANING OF FILTER CYCLES

1. The heating pump always runs during the filter cycle\*
2. In Rest Mode, heating only occurs during the filter cycle
3. Purges happen at the start of each filter cycle

\* For example, if your spa is set up for 24/hour circulation except for shutting off when the water temperature is 3°F/1.3°C above the set temperature, that shutoff does not occur during filter cycles.

# SPA CONTROLS - ICON SPA TOUCH

## RESTRICTING OPERATION

The control can be restricted to prevent unwanted use or temperature adjustments.

Locking the Panel prevents the control panel from being used, but all automatic functions are still active.

Locking the Settings allows Jets and other features to be used, but the Set Temperature and other programmed settings cannot be adjusted. Settings Lock allows access to a reduced selection of menu items. These include Filter Cycles, Invert, Information and Messages. They can be seen, but not changed or edited.

### Settings Unlocked and Panel Unlocked

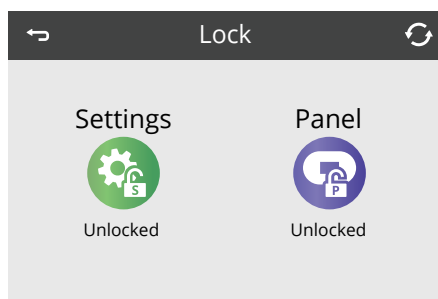
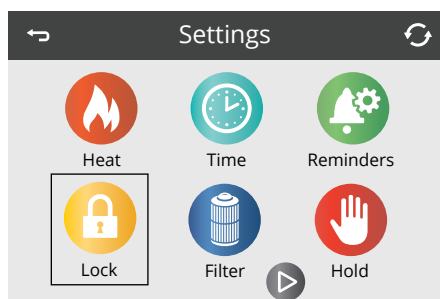

## LOCKING AND UNLOCKING

### Settings Unlocked and Panel Locked

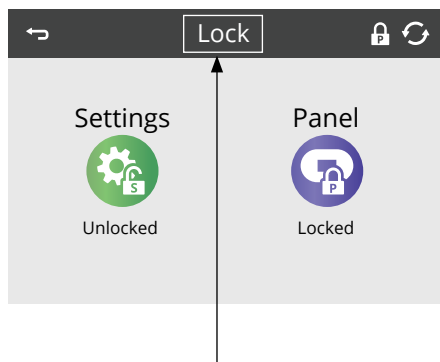

*After you have touched the Settings or Panel Icon, press here for 5 seconds to lock or unlock.*

The same steps are used to Lock and Unlock Panel or Settings.

### TO LOCK:

1. Select Settings Icon (if it says "Unlocked") or Panel Icon (if it says "Unlocked")
2. Press and hold the word "Lock" in the title bar for at least 5 seconds

### TO UNLOCK:

1. Select Settings Icon (if it says "Locked") or Panel Icon (if it says "Locked")
2. Press and hold the word "Lock" in the title bar for at least 5 seconds

 with 'S' = Settings Lock

 with 'P' = Panel Lock

# SPA CONTROLS - ICON SPA TOUCH

---

## ADDITIONAL SETTINGS

### HOLD - M037\*

The Hold Icon  on the Settings Screen places the spa in Hold Mode and displays the System Hold screen.

Hold Mode is used to disable the spa equipment during service functions like cleaning or replacing the filter. Hold Mode will last for 1 hour unless the mode is exited manually. If spa service will require more than an hour, it may be best to simply shut down power to the spa.

Touch Back to exit Hold Mode.

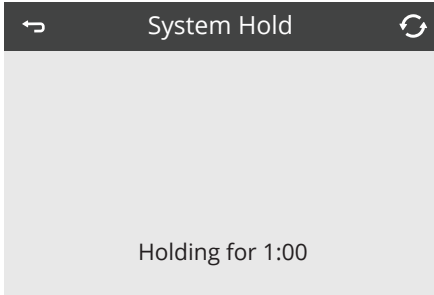

*\*M0XX is a Message Code. Codes like this will be seen in the Messages Log.*

# SPA CONTROLS - ICON SPA TOUCH

## THE UTILITIES SCREEN

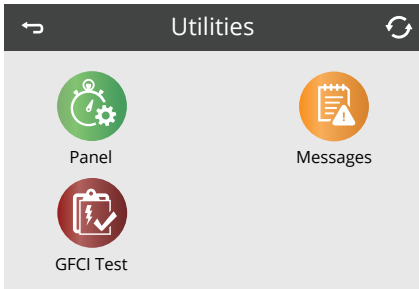

### UTILITIES

The Utilities Icon  in the Settings Screen takes you to the Utilities Screen. The Utilities Screen may contain the following:

#### PANEL

Allows you to set the time that the screen goes to sleep after so many minutes of inactivity. For example, you can set your control panel screen to shut off 10 minutes after you've last touched the screen.

#### MESSAGES LOG

The Messages Log is a record of the last 24 errors or messages that can be reviewed by a service tech. Use the Up and Down buttons to view each of the messages. When Priming Mode shows in the Messages Log, it is not an error. Rather, it is used to keep track of spa restarts.

#### GFCI TEST (Feature not available on all systems)

GFCI Test will not appear on the screen if the feature is not available. This screen allows the GFCI to be tested manually from the spa control panel (See more in Utilities - GFCI Test Feature).



# SPA CONTROLS - ICON SPA TOUCH

## ADDITIONAL SETTINGS

### UNITS

The Units Icon  on the Settings Screen takes you to the Units Screen.

Press "Temp Display" to change the temperature between Fahrenheit and Celsius.

Press "Time Display" to change the clock between 12 HR and 24 HR display.

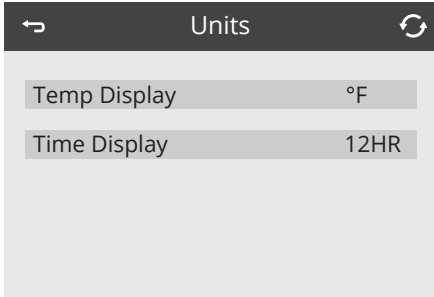

### REMINDERS

The Reminder Icon  on the Settings Screen takes you to the Reminders Screen.

Reminders are preprogrammed routine maintenance reminders that appear on the Main Screen as  at different intervals and will help guide you in taking care of your spa.

Press "Reminders" to turn them ON (which displays as Yes) or OFF (Displays as No). This will allow reminders like "Clean Filters" to appear. To see a full listing of Reminder Messages, refer to "Reminder Messages" in the back of the Spa Controls section.

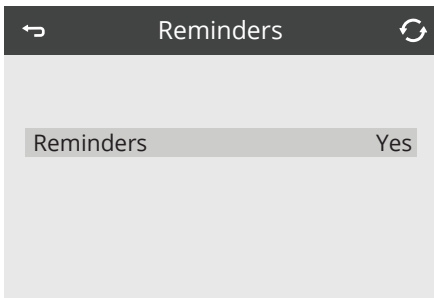

# SPA CONTROLS - ICON SPA TOUCH

## ADDITIONAL SETTINGS

### CLEANUP CYCLE

Cleanup Cycle Duration is not always enabled, so it may not appear. When it is available, set the length of time the heat/filter pump will run after each use. 0-4 hours are available. Setting to 0.0 Hr prevents the Cleanup Cycles from running.

The Cleanup Icon  on the Settings Screen takes you to the Cleanup Cycle screen.

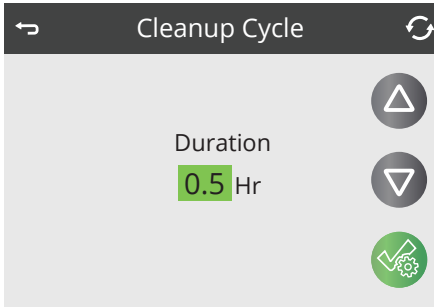

**NOTE:** Cleanup cycles do not apply to systems set for 24hr circulation pump mode as the circulation pump performs as the heat and filter pump to provide constant filtration.

### LANGUAGE

The Language Icon  on the Settings Screen takes you to the Language Screen.

Change the language displayed on the panel by pressing the arrow keys. The light grey highlight indicates the language you are changing it to.

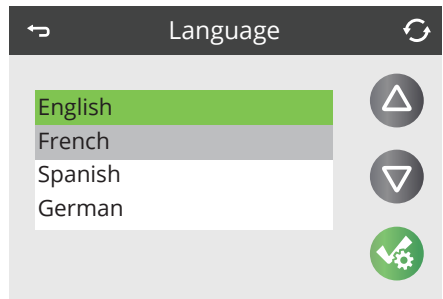
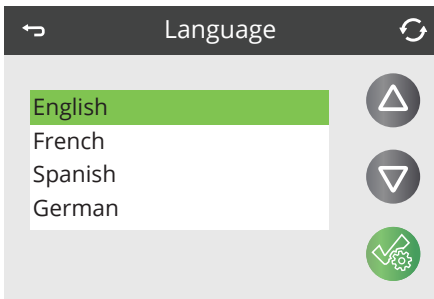

# SPA CONTROLS - ICON SPA TOUCH

## INFORMATION

### SYSTEM INFORMATION

The Information Icon  on the Settings Screen takes you to the System Information screen, which displays various settings and system identification.

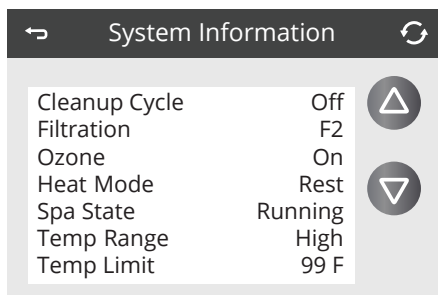

### SYSTEM MODEL

Displays the Model Number of the System.

### PANEL VERSION

Displays a number of the software in the topside control panel.

### SOFTWARE ID (SSID)

Displays the software ID number for the System.

### CONFIGURATION SIGNATURE

Displays the checksum for the system configuration file.

### CURRENT SETUP

Displays the currently selected Configuration Setup Number.

### DIP SWITCH SETTINGS

Displays a number that represents the DIP switch positions of S1 on the main circuit board.

### HEATER VOLTAGE (Feature not used on CE rated systems)

Displays the operating voltage configured for the heater.

### HEATER WATTAGE AS CONFIGURED IN SOFTWARE (CE Systems Only)

Displays a heater kilowatt rating as programmed into the control system software (1-3 or 3-6).

### HEATER TYPE

Displays a heater type ID number.

# SPA CONTROLS - ICON SPA TOUCH

## UTILITIES – GFCI TEST FEATURE

The Ground Fault Circuit Interrupter (GFCI) or Residual Current Detector (RCD) is an important safety device and is required equipment on a spa installation.



### **FORCING THE GFCI TRIP TEST** (North America Only)

Touching the GFCI Test Icon on the Utilities Screen takes you to the GFCI Test screen. This feature is not available on all systems. The GFCI Test icon will only display if the system is capable of this feature. Some UL registered systems do not have the GFCI Test Feature.

The installer can use the GFCI Trip Test to confirm proper function of the GFCI.

The GFCI should trip within several seconds and the spa should shut down. If it does not, shut down the power and manually verify that a GFCI breaker is installed and that the circuit and spa are wired correctly. Verify the function of the GFCI with its own test button. Restore power to the spa and repeat the GFCI Trip Test.

Once the GFCI is tripped by the test (causing the spa to be shut off from power being removed), reset the GFCI breaker to turn spa back on. You can verify a successful test by navigating to the above screen. “Passed” should appear after the Reset line is selected on the GFCI screen.

### **CE PRODUCT**

CE registered systems do not have an RCD Test Feature due to the nature of the electrical service. The end-user must be trained how to properly test and reset the RCD.

# SPA CONTROLS - ICON SPA TOUCH

## GENERAL MESSAGES

### MESSAGES

Most messages and alerts will appear at the bottom of the Main Screen. Several alerts and messages may be displayed in a sequence.

### WATER TEMPERATURE IS UNKNOWN

After the pump has been running for 1 minute, the temperature will be displayed.

— — — — °F      — — — — °C

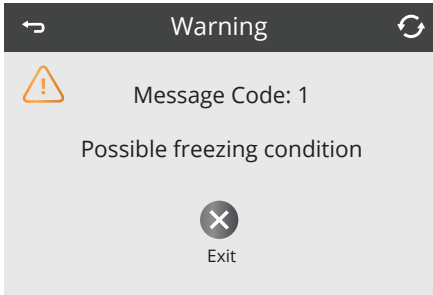

### POSSIBLE FREEZING CONDITION

A potential freeze condition has been detected, or the Aux Freeze Switch has closed. All water devices are activated. In some cases, pumps may turn on and off and the heater may operate during Freeze Protection. This is an operational message, not an error indication.

### THE WATER IS TOO HOT – M029\*

The system has detected a spa water temp of 110°F (43.3°C) or more, and spa functions are disabled. System will auto reset when the spa water temp is below 108°F (42.2°C). Check for extended pump operation (i.e. filter cycle durations or extended spa pump use beyond the 15 minute timeouts) and warm ambient temperatures.

*\*M0XX is a Message Code. Codes like this will be seen in the Messages Log.*

# SPA CONTROLS - ICON SPA TOUCH

## HEATER-RELATED MESSAGES

### THE WATER FLOW IS LOW – M016\*\*

There may not be enough water flow through the heater to carry the heat away from the heating element. Heater start up will begin again after about 1 min. See “Flow Related Checks” below.

### THE WATER FLOW HAS FAILED\* – M017\*\*

Several Heater Flow Losses have occurred within 24 hours indicating confirmed low flow or complete flow loss. There is not enough water flow being constantly maintained through the heater to carry the heat away from the heating element and the heater has been disabled. See “Flow Related Checks” below. After the problem has been resolved, reset the message\*.

### THE HEATER MAY BE DRY\* – M028\*\*

Possible dry heater, not enough water in or flowing to the heater to start it. The spa is shut down for 15 minutes but will retry (up to 3 times). Reset this message\* to reset the heater start-up. See “Flow Related Checks” below.

### THE HEATER IS DRY\* – M027\*\*

Consecutive Heater May Be Dry errors have occurred and there is a verified problem. There is a flow restriction, no flow or air lock in system preventing proper water flow for heater operation. The spa is shut down. After the problem has been resolved, you must reset the message\* to reset and restart heater. See “Flow Related Checks” below.



### THE HEATER IS TOO HOT\* – M030\*\*

One of the water temp sensors has detected 118°F (47.8°C) in the heater and the spa is shut down. You must reset the message\* when water is below 108°F (42.2°C). See “Flow Related Checks” below.

## FLOW-RELATED CHECKS

Check filters for possible blockage. Try cleaning or replacing filters (especially if spa is equipped with 24 hour circulation pump).

Check for low water level, suction flow restrictions (i.e. any leaves or debris pulled against suction fittings in bottom of spa shell), closed valves, too many closed jets and pump prime/air locked pump (see initial spa setup for instruction on relieving pump air lock).

On some systems, even when spa is shut down by an error condition, some equipment may occasionally turn on to continue monitoring the temperature or if freeze protection is needed.

\* Some messages can be reset from the panel. Messages that can be reset will appear with a Clear Icon at the bottom of the Message Screen. Press the Clear Icon to reset the system.

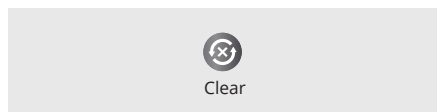

\*\*M0XX is a Message Code. Codes like this will be seen in the Messages Log.

# SPA CONTROLS - ICON SPA TOUCH

---

## SENSOR-RELATED MESSAGES

### SENSORS ARE OUT OF SYNC – M015\*\*

The temperature sensors MAY be out of sync by 3°F (1°C). Contact your Master Spas dealer or service organization if this message does not disappear within a few minutes.

### SENSORS ARE OUT OF SYNC – CALL FOR SERVICE\* – M026\*\*

The temperature sensors ARE out of sync. The fault above has been established for at least 1 hour. Contact your Master Spas dealer or service organization.

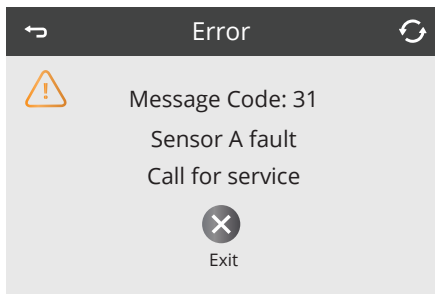

**SENSOR A FAULT, SENSOR B FAULT –  
SENSOR A: M031\*\*, SENSOR B: M032\*\***  
A temperature sensor or sensor circuit has failed. Contact your Master Spas dealer or service organization.

---

## MISCELLANEOUS MESSAGES

### COMMUNICATIONS ERROR

The control panel is not receiving communication from the System. Contact your Master Spas dealer or service organization.

### TEST SOFTWARE INSTALLED

The Control System is operating with test software. Contact your Master Spas dealer or service organization.

\* Some messages can be reset from the panel. Messages that can be reset will appear with a Clear Icon at the bottom of the Message Screen. Press the Clear Icon to reset the system.

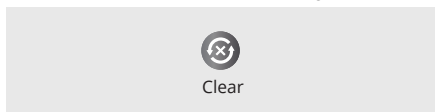

\*\*M0XX is a Message Code. Codes like this will be seen in the Messages Log.

\*\*M0XX is a Message Code. Codes like this will be seen in the Fault Log

# SPA CONTROLS - ICON SPA TOUCH

---

## SYSTEM-RELATED MESSAGES

### **PROGRAM MEMORY FAILURE\* – M022\*\***

At power-up, the system has failed the Program Checksum Test. This indicates a problem with the firmware (operation program). Contact your Master Spas dealer or service organization.

### **THE SETTINGS HAVE BEEN RESET (PERSISTENT MEMORY ERROR)\* – M021\*\***

Contact your Master Spas dealer or service organization if this message appears on more than one power-up.

### **THE CLOCK HAS FAILED\* – M020\*\***

Contact your Master Spas dealer or service organization.

### **CONFIGURATION ERROR (SPA WILL NOT START UP)**

Contact your Master Spas dealer or service organization.

### **THE GFCI TEST FAILED (SYSTEM COULD NOT TEST THE GFCI) – M036\*\***

(North America Only) May indicate an unsafe installation. Contact your Master Spas dealer or service organization as well as your electrician. A GFCI replacement will require an electrician.

### **A PUMP MAY BE STUCK ON – M034\*\***

Water may be overheated. POWER DOWN THE SPA. DO NOT ENTER THE WATER. Contact your Master Spas dealer or service organization.

### **HOT FAULT – M035\*\***

A Pump Appears to have been Stuck ON when spa was last powered POWER DOWN THE SPA. DO NOT ENTER THE WATER. Contact your Master Spas dealer or service organization.

\* Some messages can be reset from the panel. Messages that can be reset will appear with a Clear Icon at the bottom of the Message Screen. Press the Clear Icon to reset the message.

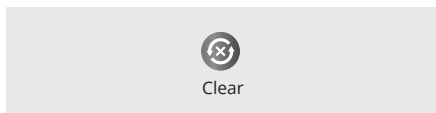

\*\*M0XX is a Message Code. Codes like this will be seen in the Messages Log.



# SPA CONTROLS - ICON SPA TOUCH

---

## REMINDER MESSAGES

### REMINDER MESSAGES OF ROUTINE MAINTENANCE

Reminder Messages can be turned off by using the Reminders Screen.

Reminders are preprogrammed routine maintenance reminders that appear on the Main Screen as  at different intervals and will help guide you in taking care of your spa. Some messages may not apply depending on the actual equipment in the spa.

### CHECK THE PH

May appear on a regular schedule, i.e. every 7 days. Check pH with a test kit and adjust pH with the appropriate chemicals.

### CHECK THE SANITIZER

May appear on a regular schedule, i.e. every 7 days. Check sanitizer level and other water chemistry with a test kit and adjust with the appropriate chemicals.

### CLEAN THE FILTER

May appear on a regular schedule, i.e. every 30 days.

### TEST THE GFCI (OR RCD)

May appear on a regular schedule, i.e. every 30 days.

The GFCI or RCD is an important safety device and must be tested on a regular basis to verify its reliability.

Every user should be trained to safely test and reset the GFCI or RCD associated with the hot tub installation.

A GFCI or RCD will have a TEST button on it that allows a user to verify proper function.

### CHANGE THE WATER

May appear on a regular schedule, i.e. every 180 days. Change the water in the spa on regular basis to maintain proper chemical balance and sanitary conditions.

Additional messages may appear on specific systems.

Reminder messages are simply cleared and automatically reset to appear at the next preprogrammed interval by clicking the Clear Icon.

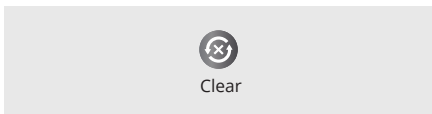

# SPA CONTROLS - ICON SPA TOUCH

---

## REMINDER MESSAGES

### **CLEAN THE COVER**

May appear on a regular schedule, i.e. every 30 days. Vinyl covers should be cleaned and conditioned for maximum life.

### **TREAT THE WOOD**

May appear on a regular schedule, i.e. every 180 days. Wood skirting and furniture should be cleaned and conditioned per the manufacturers instructions for maximum life.

### **CHANGE THE FILTER**

May appear on a regular schedule, i.e. every 365 days. Filters should be replaced periodically to maintain proper spa function and sanitary conditions. EcoPur® elements should be replaced every 180 days. Refer to Cleaning Your Filter Elements section in Routine Maintenance.

### **CHANGE THE UV**

May appear on a regular schedule, i.e. every 18 months. Change the UV as instructed in the Mast3rPur section. This is a general message and may not apply if spa is not equipped with UV.

### **CHECK OZONE**

May appear on a regular schedule, i.e. every 365 days. Check the ozone system as instructed in the Regular Maintenance Procedures.

Additional messages may appear on specific systems.

Reminder messages are simply cleared and automatically reset to appear at the next preprogrammed interval by clicking the Clear Icon.

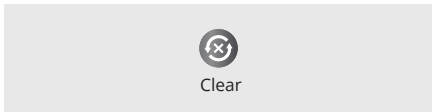

# SPA CONTROLS - PUMP CONTROL DIAGRAM

INT EVO CYCLONE (LEGEND 4)/INT ES 632

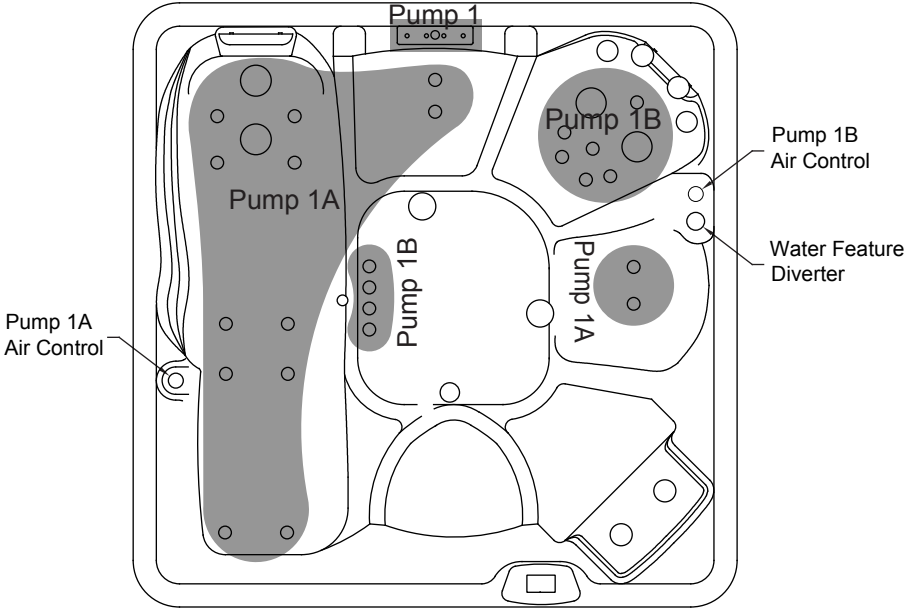

REV.012021

# SPA CONTROLS - PUMP CONTROL DIAGRAM

INT EVO HURRICANE (LEGEND 6)/INT ES 740

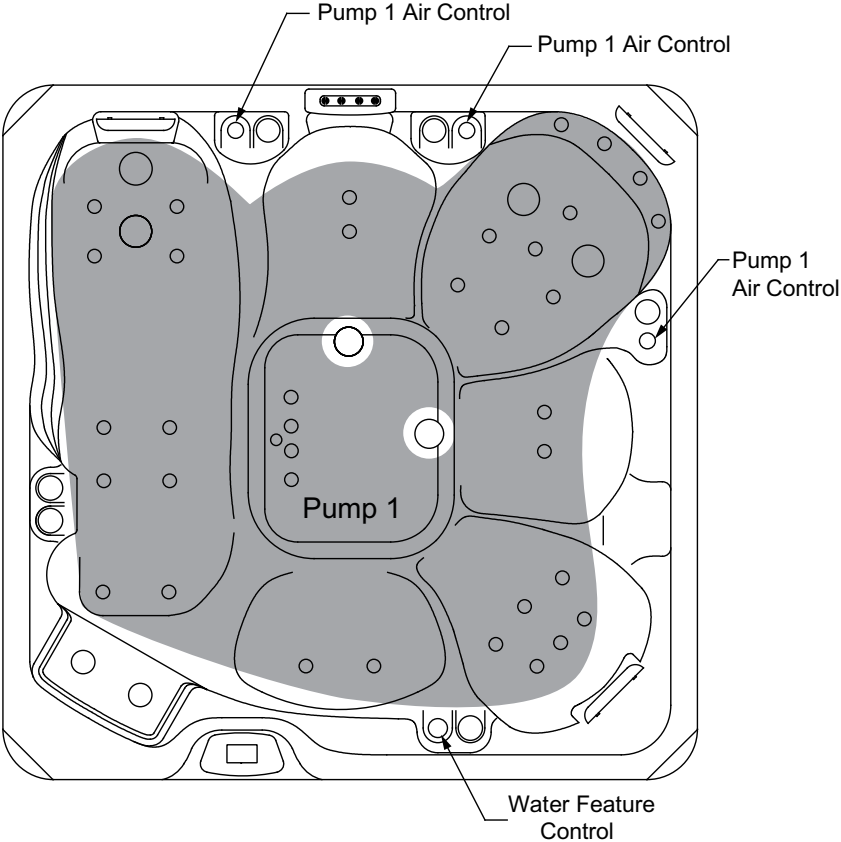

REV. 022019

# SPA CONTROLS - PUMP CONTROL DIAGRAM

INT EVO TORNADO (LEGEND 7)/INT ES 748

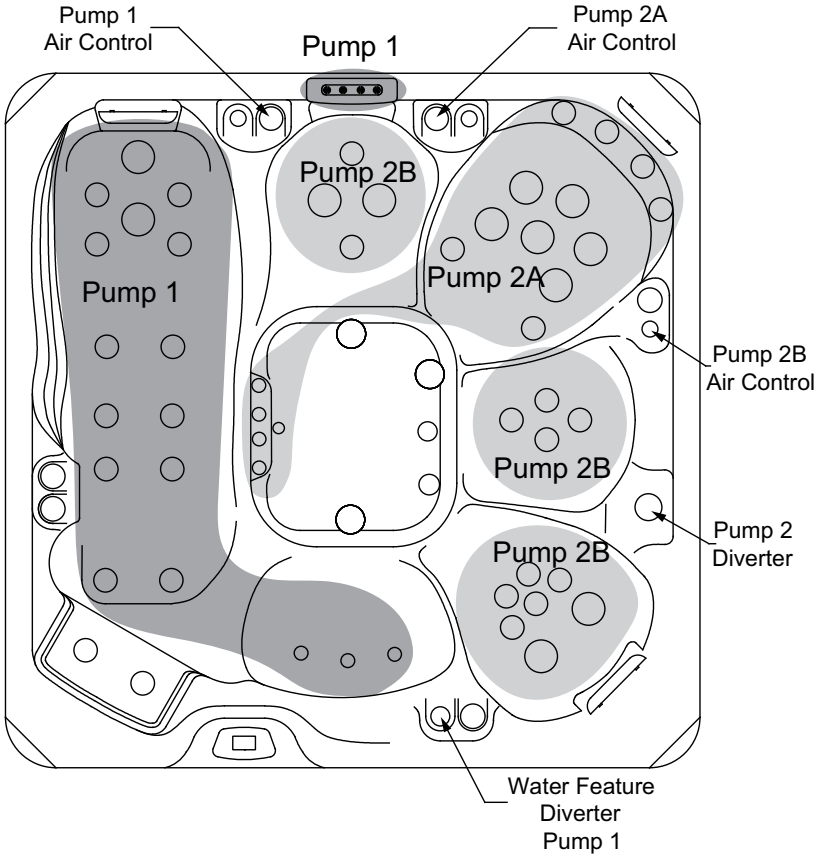

REV. 112019

## FUSION TOUCH SOUND (IF EQUIPPED)

**WARNING** – Never remain in your spa longer than 15 minutes per session when the water temperature is above 98°F (36°C). If you wish to spend more time in your spa, whether enjoying music or just lounging, be sure to keep the spa water at or below body temperature (98.6°F / 37°C).

### GETTING STARTED

The Balboa BT Audio option offers Bluetooth connection to play audio from a mobile Bluetooth audio capable device. The functions of the BBA system such as power, volume and skipping tracks can be performed from the spa topside control panel within the Music menu.

### HOME SCREEN

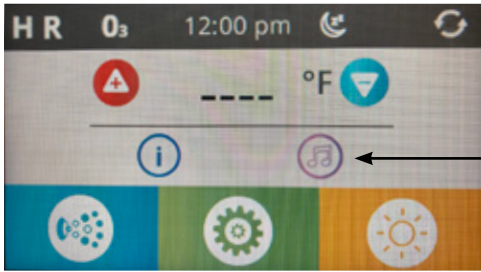

Available screen settings and button layout may vary by model.

Press this button

### BLUETOOTH SCREEN

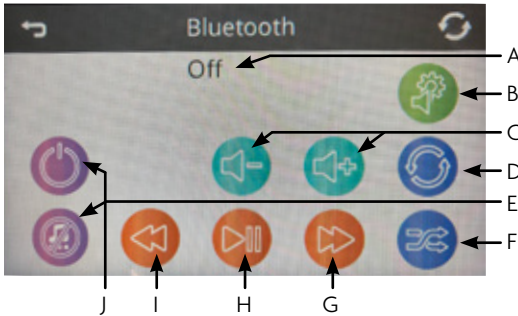

- A - Bluetooth Status/Artist, Song Length, Elapsed Time
- B - Settings
- C - Volume + / -
- D - Repeat (one song or all songs)
- E - Mute On/Off
- F - Shuffle
- G - Track Forward
- H - Play/Pause
- I - Track Back
- J - Power On/Off

Some icons such as "Repeat" may not appear if music isn't playing.

\*Internal audio module has capabilities for Bluetooth, Line In and USB. There are no external capabilities for Line In and USB. For this reason, these inputs will not be applicable when seen. Simply use Mode to rotate back to Bluetooth input.

## FUSION TOUCH SOUND (IF EQUIPPED)

---

**WARNING** – Never remain in your spa longer than 15 minutes per session when the water temperature is above 98°F (36°C). If you wish to spend more time in your spa, whether enjoying music or just lounging, be sure to keep the spa water at or below body temperature (98.6°F / 37°C).

### BLUETOOTH CONNECTION

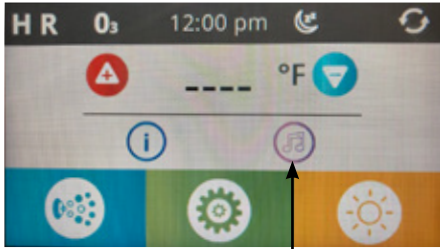

*Music Button*

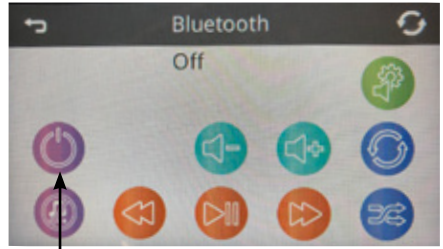

*Power Button*

1. On the topside panel, press the music button.
2. Next, press the power button.
3. Turn on Bluetooth function of your smart device or music device.
4. On your smart device or mobile device, click search for Bluetooth device. Make sure you are close to the spa. Operating Range is up to 50' (will vary, dependent on installation and objects between spa Bluetooth module and your Bluetooth device).
5. Select "PPME70BT" from the pairing list.
6. Click "Connect". Once connected, you can now play your favorite music from your smart device or mobile device.

## FUSION TOUCH SOUND (IF EQUIPPED)

**Warning** – Never remain in your spa longer than 15 minutes per session when the water temperature is above 98°F (36°C). If you wish to spend more time in your spa, whether enjoying music or just lounging, be sure to keep the spa water at or below body temperature (98.6°F / 37°C).

### ADJUST SETTINGS

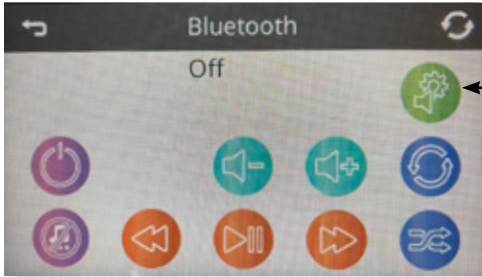

Press this button for Settings

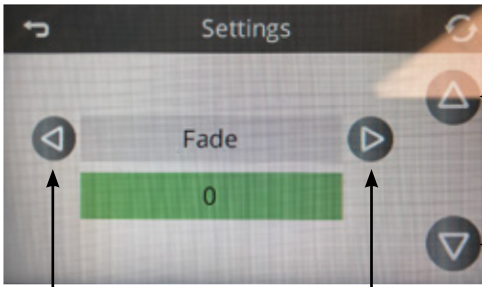

These buttons adjust Settings values

These buttons navigate to the following Settings:

- Balance
- EQ Preset
- Fade
- Filter

There are two types of audio filters: Low Pass, High Pass. These filters apply to the rear speaker output only. Select the Low Pass for subwoofers or High Pass for tweeters. Or, select OFF if filtering is not desired. Normal speakers do not require filtering.



## DREAM LIGHTING (IF EQUIPPED)

---

The optional Dream Lighting package adds beautiful, soft streams of light to accent the exterior corners of your hot tub at night. While the lighting is mostly visible at dusk or night, this low-energy LED lighting operates continuously while the spa is powered.



**Note:** This regular maintenance for the Mast3rPur™ system is not covered under the warranty of the spa. Your Master Spas dealer or service organization can be contacted to schedule this maintenance.

**WARNING** – BEFORE PERFORMING ANY MAINTENANCE ON THE MAST3RPUR™ SYSTEM, MAKE SURE THE SPA IS SHUT DOWN.

Your Mast3rPur UV/Ozone system will require the following regular maintenance to allow continued, optimal operation.

- Quartz Tube (15) should be cleaned every six months of usage.
- UV-C Lamp (20) - needs replaced every 12 months of usage (during a drain and refill maintenance point falling between this time frame).
- Ozone Cell (5) - needs replaced every 12-18 months, during a spa drain and refill.

**NOTE:** Please contact your Master Spas Dealer or service organization to perform this maintenance for you.

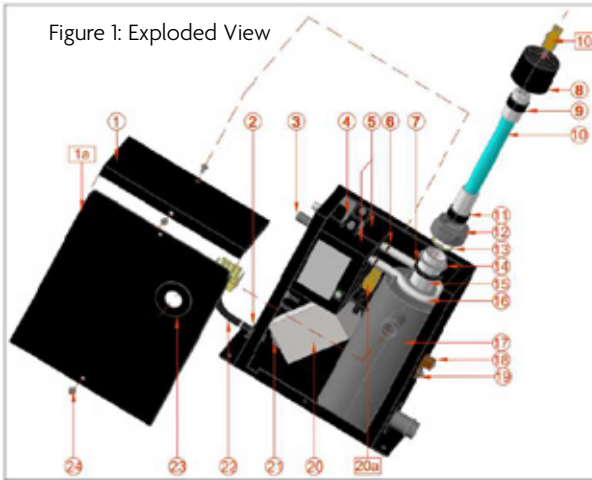

Figure 1: Exploded View

KEY	DESCRIPTION
1	ENCLOSURE TOP COVER
1a	ENCLOSURE FRONT COVER
2	STRAIN RELIEF
3*	AIR FILTER
4**	BRACKET: DUAL OZONE CELL
5***	OZONE CELL
6**	OZONE HOSE CLAMP
7	QUARTZ SEAL GASKET
8	BOOT COVER
9	UPPER CUSHION
10	UV LAMP
10a	LAMP CONNECTOR
11	LOWER CUSHION
12	COMPRESSION NUT
13	PLASTIC WASHER
14	COMPRESSION WASHER
15	QUARTZ TUBE
16**	OZONE CONNECTION HOSE
17	REACTION CHAMBER
18	GROUND LUG
19	HEX NUT
20	ELECTRONIC BALLAST
20a	BALLAST CONNECTOR
21	8 - 32x1/4" SCREW
22	POWER CORD
23	RUBBER WASHER
24	8 - 32x 5/16" SCREW

\*Item 3 as shown is for 2 ozone cells models.  
 \*\*Item 4, 6, 16 are for models with 2 ozone cells only.  
 \*\*\*Item 5 as shown is for 2 ozone cell models

## QUARTZ TUBE (6) CLEANING INSTRUCTIONS

**DANGER** – Turn the spa breaker to OFF position.

- Open the spa controller's cover and disconnect the unit from the spa controller.
- Drain the spa.

**WARNING** – Allow UV-C lamp (10) to cool down prior to removing from the unit.

**DANGER** – Never look at the lit UV-C lamp (10). This can cause severe eye damage or blindness.

- Remove water hoses from the unit as well as water inlet/outlet barbs and drain water out of the unit completely. Fold the water hoses and secure with clamp locking pliers to stop water from running out from the spa before removing them from the unit.
- Remove enclosure top cover (1) from the unit.
- Make sure to use latex glove when handling the UV-C lamp (10).

## MAST3RPUR™ (IF EQUIPPED)

---

- F. Disconnect UV-C lamp connector (10a) from ballast connector (20a).
- G. Slowly remove UV-C lamp (10) from quartz tube (15).
- H. Remove quartz seal compression nut (12).
- I. Use bare hands carefully to remove quartz seal gasket (7) and metal compression washer (14) that go over the quartz tube. Do not use any metal tools.
- J. Carefully remove the quartz tube (15).

**WARNING** – Be very careful when handling broken glass to avoid injury, and wipe off any spilled water inside the unit.

- K. Clean the quartz tube (15) with paper towel or dry cotton cloth. Do not use abrasive cleaner as that can scratch the quartz tube surface. Household tub and shower lime removal products can be used if needed. Rinse the quartz tube (15) with clean water to completely remove any cleaning products that were used.
- L. Install the quartz seal gasket (7) over the opened end of the new quartz tube (15). Place the new quartz tube (15) into the unit with the domed end first making sure it is inserted and seated inside the quartz end holder on the bottom of the reaction chamber. Only about 1/8" of quartz tube (15) will be exposed when it is seated correctly.
- M. Reinstall the compression washer (14) over the open end of the quartz tube (15). Push it against the quartz seal gasket (7).
- N. Reinstall and hand tighten the quartz seal compression nut (12) by turning it clockwise until it stops. Add another quarter of a turn by using a pair of Channel Lock pliers.
- O. Securely re-connect water hoses to the unit water inlet and outlet bars.
- P. Fill the spa. Make sure no water is dripping from the seal compression nut (12). If water is visible, STOP and tighten the compression nut another quarter of a turn with a pair of Channel Lock pliers to make sure it's completely sealed. Make sure there is no water leaking anywhere before proceeding to the next step.
- Q. Turn the breaker back on. Turn on the pump to circulate the water through the unit. Wait for 5 minutes and assure no water is dripping. If water is visible, STOP, fix the leak by repeating the quartz tube maintenance process from step (a) to step (o). Ensure no water dripping from the seal compression nut (12) or water inside quartz tube (15) before proceeding to next step.
- R. Turn the pump OFF, then turn the breaker OFF before proceeding to the next step.
- S. Slide the UV-C lamp (10) back inside the quartz tube (15).
- T. Reconnect the UV-C lamp connector (10a) to the ballast connector (20a). Make sure the connectors mate completely. Do not use force. Line up the locking tabs on connector (10a) with connector (10b).
- U. Reinstall the enclosure top cover (1) then secure with screws removed previously.
- V. Reconnect the water hoses back to the unit & secure with clamps.
- W. Reconnect the unit to the spa controller and reinstall the spa controller's cover.
- X. Turn ON the power to the spa.
- Y. Once power is activated you can check the LEDs to see if the unit is functioning. A solid green light indicates the unit is being provided power and should always be on. A solid blue light indicates that UV-C lamp is activated.

## MAST3RPUR™ (IF EQUIPPED)

---

**NOTE:** Only use a proper replacement UV-C lamp (10), which can be acquired through your Master Spas Dealer or service organization.

### UV-C LAMP (10) REPLACEMENT INSTRUCTIONS

**DANGER** – Turn the spa breaker to OFF position.

- A. Open the spa controller's cover and disconnect the unit from the spa controller.

**WARNING** – Allow UV-C lamp (10) to cool down prior to removing from the unit.

**Danger** – Never look at the lit UV-C lamp (10). This can cause severe eye damage or blindness.

- B. Drain the spa.
- C. Remove water out of the Mast3rPur unit completely.
- D. Remove enclosure top cover (1).
- E. Make sure to use latex gloves when handling the UV-C lamp (10).
- F. Slowly disconnect the old UV-C lamp connector (10a) from ballast connector (20a).
- G. Slowly remove old UV-C lamp (10) from quartz tube (15). Save the upper cushion (9) and lower cushion (11).
- H. Install the upper cushion (9) and lower cushion (11) to the NEW UV-C lamp (10).
- I. Slide the NEW UV-C lamp (10) into the quartz tube (15).
- J. Reconnect the NEW UV-C lamp connector (10a) to the ballast connector (20a). Make sure the connectors mate completely. Do not use force. Line up locking tabs on connector (10a) to connector (20a).
- K. Reinstall the enclosure top cover (1) and secure with the screws removed previously.
- L. Reconnect the unit to the spa controller and reinstall the spa controller's cover.
- M. Turn ON the power to the spa.
- N. Once power is activated you can check the LEDs to see if the unit is functioning. A solid green light indicates the unit is being provided power and should always be on. A solid blue light indicates that UV-C lamp is activated.

**WARNING** – The UV-C lamp used in this unit contains mercury. Properly dispose the old UV-C lamp in accordance with disposal laws. See [www.lamprecycle.org](http://www.lamprecycle.org).

**NOTE:** This International Limited Warranty applies to residential use outside of the United States and Canada.

## **5 YEARS - SPA STRUCTURE**

Master Spas warrants to the original retail purchaser the structural integrity of the spa against water loss from the spa due to defects in material or workmanship, in the spa structure for a period of 5 years from the date of the original retail purchase. Master Spas will either repair, including the parts and labor to repair the spa structure or replace the nonconforming Spa Structure. In the event of replacement, the cost of labor and equipment for removal and replacement of the unit is the sole responsibility of the Purchaser.

## **5 YEARS - SHELL SURFACE**

Master Spas warrants to the original retail purchaser that the acrylic finish will not blister, crack or delaminate for a period of 5 years from the date of original retail purchase as a result of defects in material or workmanship. Master Spas will either repair, including the parts and labor to repair the shell surface or replace the nonconforming shell. In the event of replacement, the cost of labor and equipment for removal and replacement of the unit is the sole responsibility of the Purchaser. There is no Shell Surface Warranty on blemished units.

## **2 YEARS - EQUIPMENT**

Master Spas warrants to the original retail purchaser the spa equipment (pumps, heater and control system) should a component of the Equipment Pack fail or malfunction due to defects in material and workmanship, for a period of 2 years from the date of the original retail purchase. Master Spas will either repair or replace the applicable component, including replacement parts and labor to install them (parts and labor).

## **2 YEARS - PLUMBING**

Master Spas warrants to the original retail purchaser for a period of 2 years from the date of original retail purchase that the plumbing of the spa will not leak due to defects in material and workmanship (Master Spas will provide replacement parts and labor to repair or replace the applicable components).

## **2 YEARS - JETS**

Jet internals are warranted against malfunctions due to defects in material for a period of 2 years from the date of original retail purchase (Master Spas will provide replacement jet internal parts only). The cost of shipping and installation of any jet internals is the sole responsibility of the purchaser. After initial delivery and startup, discoloring or fading of the plastics, corrosion of any stainless steel components and sticking/seizing of the adjustable jet internals or their spinning nozzles are specifically excluded from these warranty terms.

## **LIFETIME - SKIRTING\* (DuraMaster Polymer™)**

Master Spas warrants to the original retail purchaser only that the DuraMaster Polymer™ skirting will not crack or rip for the life of the spa. Bowing that can occur under some conditions is considered normal and excluded by this limited warranty. Normal wear and weathering that occur overtime are not defects. If the skirting on the spa fails due to defects in materials or workmanship, Master Spas will replace the applicable skirting components (parts only). The cost of shipping and installation of any replacement skirting is the sole responsibility of purchaser.

**NOTE: This International Limited Warranty applies to residential use outside of the United States and Canada.**

### **1 YEAR - LED LIGHT SYSTEM\***

Master Spas warrants to the original retail purchaser, for a period of 1 year from the date of original retail purchase that the optional, factory installed LED light system will not malfunction due to defects in workmanship and materials (parts and labor). If the LED light system or any component thereof fails due to defects in material or workmanship, Master Spas will either repair or replace the applicable components.

### **1 YEAR - DREAM LIGHTING\***

Master Spas warrants to the original retail purchaser, for a period of 1 year from the date of original retail purchase, that the optional, factory installed Dream Lighting system in the spa skirt will not malfunction due to defects in workmanship and materials. If the Dream Lighting system or any of its components thereof has malfunctioned due to defects in workmanship or materials, Master Spas will either repair or replace the applicable components of the Dream Lighting system (parts and labor).

### **1 YEAR - OZONATOR\***

Master Spas warrants to the original retail purchaser that the factory installed ozonator will not malfunction due to defects in materials or workmanship for a period of 1 year from the date of original retail purchase. If the ozonator malfunctions due to a defect in materials or workmanship, Master Spas will either repair or replace the applicable components including parts and labor.

### **1 YEAR - MAST3RPUR SYSTEM\***

Master Spas warrants to the original retail purchaser that the factory installed Mast3rPur system will not malfunction due to defects in materials or workmanship for a period of 1 year from the date of original retail purchase. If the Mast3rPur system malfunctions due to a defect in materials or workmanship, Master Spas will either repair or replace the applicable components including parts and labor.

### **1 YEAR - AUDIO EQUIPMENT\***

Master Spas warrants to the original retail purchaser, the optional stereo and enclosure components within the audio system against malfunctions due to defects in material and workmanship for a period of 1 year (parts). This limited warranty on all optional Audio Equipment covers labor for a period of 1 year from the date of original retail purchase. After 1 year, the purchaser is solely responsible for any labor costs associated with the repair or replacement of any applicable audio components. Master Spas shall not be responsible for any damages or losses to any accessories (not supplied by Master Spas), including but not limited to iPods or similar systems, caused by a defect or malfunction of any Master Spas supplied component.

## **EXCLUSIONS**

This limited warranty is enforceable only by the original retail purchaser from the date of original retail purchase but is voidable if the entire purchase price has not been paid to retail dealer. Light bulbs, light lenses, fuses, overlays/labels, covers, spa pillows or any dealer installed accessories are specifically excluded from this limited warranty. All warranties are void if the spa is placed in commercial service. Any spa in service at a residential rental property, the warranty periods are reduced as follows: any warranty period of 4 years or more, are reduced to 2 years; any warranty period of 2 to 3 years, are reduced to 1 year; any warranty periods of 1 year or less, remain the same. Normal wear and weathering of finishes and components are not defects and specifically excluded from this limited warranty. In the event it is necessary to remove the spa from the residential premises to repair or replace any warrantable item, any and all cost of spa removal and replacement including but not limited to removal of the original spa and transportation of the replacement spa, damages to landscaping, decking, fencing or other structural alteration, or any cost related to obtaining access to the spa are the sole responsibility of the purchaser. Spa covers are not included or covered by this spa warranty. Freight/shipping costs for any warrantable replacement item is the sole responsibility of the purchaser.

## **LIMITATIONS**

This limited warranty is voidable if the spa has been subject to misuse, alteration or attempted alteration, repairs or attempted repairs by a non-approved service center or if a failure or malfunction is due to improper installation, improper water chemistry, improper maintenance or lack of normal maintenance as prescribed in the Master Spas Owner's Manual, an act of God, weather conditions, animals, rodents, pests or any damage from causes beyond the control of Master Spas. Misuse or abuse shall mean operation of the spa other than in conformity with the Master Spas Owner's Manual. Such misuse and abuse shall include but not be limited to the following:

- Damage of the spa surface and components caused by leaving the spa uncovered or due to covering the spa with plastic film of any kind.
- Damage to the spa surface and components caused by use of a non-insulating cover or an unapproved cover not manufactured by Master Spas when the spa is subject to weather conditions and sun.
- Damage to the spa surface and components caused by contact with unapproved cleaners or solvents.
- Damage caused by operation of the spa at water temperatures outside the range of 34° F - 104° F.
- Freeze damage.
- Damage caused by unapproved sanitizers such as calcium hypochlorite, sodium hydroxide, "tri-chlor" type chlorines or any sanitizing chemical that may remain undissolved on the spa surface.
- Damages or malfunction due to a dirty, clogged, calcified filters or use of an unapproved filter cartridge.
- Damages or malfunction caused by failure to provide even, proper support for the spa.
- Damages or malfunction caused during installation of the spa.
- Damages or malfunction caused by use of unapproved filter cartridges.

**WARRANTY REGISTRATION AND WARRANTY CLAIM PROCEDURE**

The original retail purchaser should register their spa purchase within 10 days from the date of original retail purchase to establish proof of purchase with Master Spas. Failure to register does not void this limited warranty but, upon any warranty claim, proof of purchase must first be provided to confirm original retail purchase date to the original retail purchaser. Spa Registration can be submitted online at [www.masterspas.com/resources](http://www.masterspas.com/resources). In the event of a warranty claim of a defect or malfunction covered under the provisions of this limited warranty, the original retail purchaser must first notify in writing the retail dealer who sold the spa within ten (10) days of the initial malfunction or discovery of defect. If the retail dealer does not provide service, then the purchaser should contact Master Spas customer service department, via the web site, or provide written notice of the malfunction or defect at the address below. Upon notice of the warranty claim, the retail dealer or an approved independent service center representative will arrange inspection of the spa with the retail purchaser to determine if the claimed malfunction or defect is a covered malfunction or defect under this limited warranty. If it is determined that the malfunction is not covered by this limited warranty, the cost of the service call is the sole responsibility of the purchaser. If it is determined that the malfunction or defect is covered under this limited warranty, Master Spas through the retail dealer, or approved independent service center will repair or replace the covered item. In the event of spa replacement, the replacement spa will carry the balance of the original spa warranty from the original retail purchase date. Master Spas reserves the right for its dealers or approved service centers to collect from the retail purchaser reasonable travel expenses. In addition, access charges will be assessed if the spa is not reasonably accessible for inspection, repair or replacement. This limited warranty is extended only to the original retail purchaser and is not transferable. This limited warranty becomes void upon the transfer of ownership of the spa or moving of the spa to a different location.

**DISCLAIMERS**

MASTER SPAS LLC, NEITHER ASSUMES NOR DO WE AUTHORIZE ANY OTHER PERSON TO ASSUME FOR US, ANY OTHER LIABILITY IN CONNECTION WITH THE SALE OF SPAS MANUFACTURED BY MASTER SPAS. THIS LIMITED WARRANTY SHALL BE THE EXCLUSIVE REMEDY AVAILABLE TO A PURCHASER AND MASTER SPAS SHALL NOT BE LIABLE FOR ANY INCIDENTAL OR CONSEQUENTIAL DAMAGES RESULTING FROM MISUSE OF THE SPA OR CAUSED BY ANY DEFECT, FAILURE OR MALFUNCTION OF THE SPA, WHETHER A CLAIM IS BASED UPON WARRANTY, CONTRACT, NEGLIGENCE OR OTHERWISE. SOME STATES DO NOT ALLOW THE EXCLUSION OF INCIDENTAL OR CONSEQUENTIAL DAMAGES, SO THIS LIMITATION MAY NOT APPLY TO YOU.

TO THE EXTENT PERMITTED BY APPLICABLE LAW, THIS LIMITED WARRANTY SPECIFICALLY EXCLUDES ANY AND ALL IMPLIED WARRANTIES OF MERCHANTABILITY AND/OR FITNESS FOR A PARTICULAR PURPOSE, OTHERWISE ALL IMPLIED WARRANTIES ARE LIMITED IN DURATION TO TWO (2) YEARS FROM THE ORIGINAL DATE OF RETAIL PURCHASE. SOME JURISDICTIONS DO NOT ALLOW THE LIMITATION OF THE DURATION OF IMPLIED WARRANTIES, SO THIS LIMITATION MAY NOT APPLY TO YOU. THERE ARE NO OTHER WARRANTIES, EITHER EXPRESSED OR IMPLIED, OF ANY KIND OR NATURE WHICH EXTEND BEYOND THE DESCRIPTION ON THE FACE HEREOF. SOME JURISDICTIONS DO NOT ALLOW THE LIMITATIONS OF REMEDIES SO THESE LIMITATIONS MAY NOT APPLY TO YOU.

IF YOUR SPA IS DESIGNATED BY MASTER SPAS AS A "BLEM" OR AS "BLEMISHED", THE SHELL SURFACE IS NOT WARRANTED AND THE SPA IS PURCHASED "AS IS" REGARDING ANY COSMETIC BLEMISHES.



# SPA CARE AND MAINTENANCE RECORD

---

## MAINTENANCE AVERAGE TIMETABLES

Below is a list of routine maintenance and the guidelines on how often they should be done. The frequency in which these actions should be performed may vary depending on bather load and how often you use your spa.

- Test GFCI - Before each use
- Clean Filter Cartridge - at least once a month
- Clean and Condition Spa Cover - twice a month
- Drain and Clean Spa - every 6 months

## MAINTENANCE LOG

Use the following lines to document your spa care and maintenance.

MAINTENANCE PERFORMED	DATE	DATE	DATE
_____	_____	_____	_____
_____	_____	_____	_____
_____	_____	_____	_____
_____	_____	_____	_____
_____	_____	_____	_____
_____	_____	_____	_____
_____	_____	_____	_____
_____	_____	_____	_____
_____	_____	_____	_____
_____	_____	_____	_____
_____	_____	_____	_____
_____	_____	_____	_____
_____	_____	_____	_____
_____	_____	_____	_____
_____	_____	_____	_____
_____	_____	_____	_____
_____	_____	_____	_____
_____	_____	_____	_____
_____	_____	_____	_____
_____	_____	_____	_____
_____	_____	_____	_____
_____	_____	_____	_____



# Acrylic Spa Models

EVO, LEGEND FAMILY, STORM RANGE, ES



Customer Service: [www.masterspas.com/resources](http://www.masterspas.com/resources)

6927 Lincoln Parkway, Fort Wayne, IN 46804

800.860.7727 [CustomerService@MasterSpas.com](mailto:CustomerService@MasterSpas.com)

Stay Connected, Keep in Touch



@MasterSpas

#masterspas

Manufactured and assembled in the U.S.A with domestic and foreign components. Master Spas® reserves the right to change product specifications or features without notice. Master Spas is a manufacturer of spas and related products, and we stand behind every product we produce pursuant to those representations which are stated in our written limited warranty. Your dealer is an independent businessperson or company and not an employee or agent of Master Spas, LLC. We cannot and do not accept any responsibility or liability for any other representations, statements or contracts made by any dealer beyond the provisions of our written limited warranty. Master Spas, Michael Phelps Legend Series, Master Blaster, and EcoPur are registered trademarks of Master Spas, LLC. The Ultimate Relaxation Machine, Mast3rPur, DreamStone, and DuraMaster are all trademarks of Master Spas, LLC. Patents: [masterspas.com/patents](http://masterspas.com/patents).