



OWNER'S MANUAL & LIMITED WARRANTY

INTERNATIONAL VERSION



MASTER SPAS OWNER'S MANUAL

Welcome to the Ultimate in Relaxation!

Thank you for choosing your new spa built by Master Spas. For how-to videos and helpful tips on operating and maintaining your spa, please visit www.masterspas.com/resources.

Please read the entire Owner's Manual before installing and using your spa. The goal of this manual is to provide you with safety and operational information plus some tips that will help you enjoy your spa to its fullest. At the time of print, this manual is accurate in its information. Master Spas reserves the right to change or improve its product without prior notice.

REGISTER YOUR SPA

Please be sure to register your spa so we can efficiently assist with any questions you may have. Until your spa has been registered, Master Spas will not have record of your ownership. To register your spa, visit www.masterspas.com/resources and click on Spa Registration.

SERIAL NUMBER LOCATION

The serial number for your spa is located near the filter area, on the spa system pack, or on the listing plate on the spa frame behind the front skirt panel. It is a seven digit number on most models or an "R" followed by 6 digits. For example, 2212345 or R221234.

RECORD OF OWNERSHIP

Name _____

Address _____

City _____ State _____ Zip _____

Phone Number (____) _____ - _____ Date Purchased ____/____/____

Model _____ Serial # _____

Dealer Name _____

Service Tech Rep _____



WATCH HOW-TO VIDEOS:
masterspas.com/video-tutorials



RELAX. IT'S

Master Spas®

6927 Lincoln Parkway
Fort Wayne, IN 46804
masterspas.com

TABLE OF CONTENTS

| | |
|--|-------|
| Safety Instructions | 2-10 |
| Regulations | 11-13 |
| Compliance | 14 |
| VGB Suction Safety & Maintenance Instructions | 15-16 |
| Glossary of Spa Terminology | 17-19 |
| The Advantages of EcoPur® Charge | 20-21 |
| Water Chemistry Terms You Should Know | 22-23 |
| Why Are Chemicals Important in a Spa | 24 |
| Water Maintenance | 25-28 |
| Recommended Ranges | 25 |
| Start-Up | 26 |
| Schedule | 27 |
| Troubleshooting Guide | 28 |
| Regular Maintenance Procedures | 29-36 |
| Spa Troubleshooting Guide | 37-38 |
| Winterizing & Storing Your Spa | 39 |
| Model Specifications | 40 |
| Installation Instructions | 41-49 |
| Site Preparation / General Guidelines | 41-43 |
| Electrical Requirements | 44-47 |
| Initial Spa Setup | 48-49 |
| Operating Instructions | 50-71 |
| Spa Controls - MP30/TP600 | 50-59 |
| Spa Controls - Pump Diagrams | 60-65 |
| Fusion Air Sound System (if equipped) | 66-70 |
| Dream Lighting (if equipped) | 71 |
| International Limited Warranty | 72-75 |
| Spa Care & Maintenance Record | 76-81 |

SAVE THESE INSTRUCTIONS

Included with your new spa is a safety sign. The sign is for you and your guest's protection and is suitable for outdoor use in wet locations. The sign should be placed in a location visible to all users of the spa.

Please take time to point out the physical location of the safety sign and the importance of the safety precautions displayed on the safety sign to all of your guests. Remember, your safety and the safety of anyone who enjoys the use of your spa is our utmost concern.

The sign should be mounted with screws or another type of permanent fastener. Additional or replacement signs can be obtained from your dealer or direct from the factory.

INTRODUCTION

It's time to relax! You now have your very own portable spa by Master Spas. By fully understanding the operation of each of the features of your new Master Spa, you will be assured of many years of hassle-free, hot water therapy and fun.

Your safety is of paramount importance to the Master Spas family. We urge you to carefully read, understand, and follow all information in this user manual before installing and using the spa. These warnings, instructions, and safety guidelines address some common risks of water recreation, but they cannot cover all risks and dangers in all cases. Always use caution, common sense, and good judgment when enjoying any water activity. Retain this information for future use.

Through reading and totally understanding the important information in your owner's manual, you will realize that you now own **THE ULTIMATE RELAXATION MACHINE!**[®]



**Safety graphical symbol ISO 7010, M002 –
Refer to instruction manual/booklet**

NO DIVING

**DANGER: DIVING MAY
RESULT IN SERIOUS
INJURY OR DEATH.**



IMPORTANT SAFETY INSTRUCTIONS

This spa is not intended for public/commercial use.

When installing and using this electrical equipment, basic safety precautions should be observed including the following:

READ AND FOLLOW ALL INSTRUCTIONS

WARNING – To reduce the risk of injury, do not permit children to use this product unless they are closely supervised at all times.

A wire conductor is provided on this unit to connect a minimum 6 AWG (13.302mm²) solid copper conductor between this unit and any metal equipment, metal enclosures of electrical equipment, metal water pipe, or conduit within 5 feet (1.5m) of the unit.

(For cord-connected/convertible units)

DANGER – Risk of injury.

- a) Replace damaged cord immediately.
- b) Do not bury cord.
- c) Connect to a grounded, grounding type receptacle only.

(For units intended for indoor use only)

WARNING – For indoor use only. This unit is not intended for outdoor use.

(For units intended for outdoor use only)

WARNING – For outdoor use only. This unit is not intended for indoor use.

SAFETY INSTRUCTIONS

NO DIVING

**DANGER: DIVING MAY
RESULT IN SERIOUS
INJURY OR DEATH.**



IMPORTANT SAFETY INSTRUCTIONS (CONT.)

(For units with GFCI)

WARNING – This product is provided with a ground-fault circuit interrupter located on the front panel of selected swim spas and on the power cord of 120 volt convertible spas. The GFCI must be tested before each use. With the product operating, open the service door. When the product stops operating, this merely indicates that the door is equipped with an electrical interlock. Next, push the test button on the GFCI and close the service door. The product should not operate. Now open the service door, push the reset button on the GFCI and close the service door. The product should now operate normally. When the product fails to operate in this manner, there is a ground current flowing indicating the possibility of an electric shock. Disconnect the power until the fault has been identified and corrected.

DANGER – Risk of Accidental Drowning. Extreme caution must be exercised to prevent unauthorized access by children. To avoid accidents, ensure that children cannot use this spa unless they are supervised at all times.

DANGER – Risk of Injury. The suction fittings in this spa are sized to match the specific water flow created by the pump. Should the need arise to replace the suction fittings or the pump, be sure that the flow rates are compatible. Never operate spa if the suction fittings are broken or missing. Never replace a suction fitting with one rated less than the flow rate marked on the original suction fitting.

DANGER – Risk of Electric Shock. Install at least 5 feet (1.5m) from all metal surfaces. As an alternative, a spa may be installed within 5 feet of metal surfaces if each metal surface is permanently connected by a minimum 8AWG (8.4mm²) solid copper conductor to the wire connector on the terminal box that is provided for this purpose. Be sure to review and comply with any overruling local or national applicable regulations.

DANGER – Risk of Electric Shock. Do not permit any electric appliance, such as a light, telephone, radio, or television, within 5 feet (1.5 m) of a spa.

WARNING – To reduce the risk of injury:

- a) The water in a spa should never exceed 104°F (40°C). Water temperatures between 100°F (38°C) and 104°F (40°C) are considered safe for a healthy adult. Lower water temperatures are recommended for young children and when spa use exceeds 10 minutes. Persons with any medical condition should seek medical advice before using a spa.

SAFETY INSTRUCTIONS

| | | |
|------------------|--|---|
| NO DIVING | DANGER: DIVING MAY RESULT IN SERIOUS INJURY OR DEATH. |  |
|------------------|--|---|

IMPORTANT SAFETY INSTRUCTIONS (CONT.)

- b) Since excessive water temperatures have a high potential for causing fetal damage during the early months of pregnancy, pregnant or possibly pregnant women should limit spa water temperatures to 100°F (38°C) and duration of use and should also seek medical advice.
- c) Before entering a spa, the user should measure the water temperature with an accurate thermometer since the tolerance of water temperature-regulating devices varies.
- d) The use of alcohol, drugs, or medication before or during spa use may lead to unconsciousness with the possibility of drowning.
- e) Obese persons and persons with a history of heart disease, low or high blood pressure, circulatory system problems, or diabetes should consult a physician before using a spa.
- f) Persons using medication should consult a physician before using a spa since some medication may induce drowsiness while other medication may affect heart rate, blood pressure, and circulation.

(For spas with a gas heater)

WARNING – Risk of Suffocation. This spa is equipped with a gas heater and is intended for outdoor use only unless proper ventilation can be provided for an indoor installation.

SAVE THESE INSTRUCTIONS

HYPERTHERMIA

Hyperthermia occurs when the internal temperature of the body reaches a level several degrees above the normal body temperature of 98.6°F (37°C). Prolonged immersion in hot water may induce hyperthermia.

THE SYMPTOMS OF HYPERTHERMIA INCLUDE:

- Dizziness • Fainting • Drowsiness • Lethargy
- Increase in Internal Body Temperature

THE EFFECTS OF HYPERTHERMIA INCLUDE:

Unawareness of Impending Hazard • Failure to Perceive Heat • Failure to Recognize the Need to Exit Spa • Physical Inability to Exit Spa • Fetal Damage in Pregnant Women • Unconsciousness Resulting in a Danger of Drowning

WARNING – The use of alcohol, drugs, or medication can greatly increase the risk of hyperthermia.

SAFETY INSTRUCTIONS

NO DIVING

**DANGER: DIVING MAY
RESULT IN SERIOUS
INJURY OR DEATH.**



IMPORTANT SAFETY INSTRUCTIONS (CONT.)

DANGER – To reduce the risk of injury to persons, do not remove the suction grate. Suction through drains and skimmers is powerful when the jets in the spa are in use. Damaged covers can be hazardous to small children and adults with long hair. Should any part of the body be drawn into these fittings, turn off the spa immediately. As a precaution, long hair should not be allowed to float in the spa.



EN 17125 – Do not put finger in massage jet

WARNING – Install the spa so that water can be easily drained out of the compartment containing electrical components so as not to damage equipment. When installing the spa make sure to allow for an adequate drainage system to deal with any overflow water. Please allow for at least 3 feet of clearance around the perimeter of the spa to provide enough room to access for servicing. Contact your local dealer for their specific requirements.

WARNING – The spa should be covered with an approved locking cover when not in use, to prevent unauthorized entry and injuries.

WARNING – People with infections, sores or the like should not use the spa. Warm and hot water temperatures may allow the growth of infectious bacteria if not properly disinfected.

CAUTION – Safe temperatures for swimming or aquatic exercise is around 80°F (26.7°C).

CAUTION – Risk of Electrical Shock. Do not leave audio compartment open. Audio CD controls are not to be operated while inside the spa.

CAUTION – Replace components only with identical components.

WARNING – Risk of Electric Shock. Do not connect any auxiliary components (for example, additional speakers, headphones, additional audio/ video components etc.) to the system. These units are not provided with an outdoor antenna.

Do not service this product yourself as opening or removing covers may expose you to dangerous voltage or other hazards. Refer all servicing to qualified service personnel. If the power supply cord(s) are damaged, water is entering the speaker, audio compartment, or any other component in the electrical equipment compartment area, the protective shield is showing signs of deterioration, or there are signs of other potentially hazardous damage to the unit, turn off the circuit breaker from the wall and refer servicing to qualified personnel.

| | | |
|------------------|--|---|
| NO DIVING | DANGER: DIVING MAY RESULT IN SERIOUS INJURY OR DEATH. |  |
|------------------|--|---|

IMPORTANT SAFETY INSTRUCTIONS (CONT.)

The unit should be subjected to periodic routine maintenance once every quarter to make sure that the it is operating properly.

DANGER – Risk of Electric Shock. A green colored terminal or a terminal marked G, GR, Ground, Grounding or the symbol shown in Figure 14.1 of UL 1563 is located inside the supply terminal box or compartment. To reduce the risk of electric shock, this terminal must be connected to the grounding means provided in the electric supply service panel with a continuous copper wire equivalent in size to the circuit conductors supplying this equipment.

At least two lugs marked “Bonding Lugs” are provided on the external surface or on the inside of the supply terminal box or compartment. To reduce the risk of electric shock, connect the local common bonding grid in the area of the spa to these terminals with an insulated or bare copper conductor not smaller than 8AWG.

All field installed metal components such as rails, ladders, drains, or other similar hardware within 10 feet (3m) of the spa shall be bonded to the equipment grounding bus with copper conductors not smaller than 8AWG.

SAVE THESE INSTRUCTIONS

SAFETY INSTRUCTIONS

WARNING: CHILDREN SHOULD NOT USE SPAS OR HOT TUBS WITHOUT ADULT SUPERVISION.

AVERTISSEMENT: NE PAS LAISSER LES ENFANTS UTILISER UNE CUVE DE RELAXATION SANS SURVEILLANCE.

WARNING: DO NOT USE SPAS OR HOT TUBS UNLESS ALL SUCTION GUARDS ARE INSTALLED TO PREVENT BODY AND HAIR ENTRAPMENT.

AVERTISSEMENT: POUR ÉVITER QUE LES CHEVEUX OU UNE PARTIE DU CORPS PUISSENT ÊTRE ASPIRES, NE PAS UTILISER UNE CUVE DE RELAXATION SI LES GRILLES DI PRISE D'ASPIRATION NE SONT PAS TOUTES EN PLACE.

WARNING: PEOPLE USING MEDICATIONS AND/OR HAVING AN ADVERSE MEDICAL HISTORY SHOULD CONSULT A PHYSICIAN BEFORE USING A SPA OR HOT TUB.

AVERTISSEMENT: LES PERSONNES QUI PRENNENT DES MÉDICAMENTS OU ONT DES PROBLÈMES DE SANTÉ DEVRAIENT CONSULTER UN MÉDECIN AVANT D'UTILISER UNE CUVE DE RELAXATION.

WARNING: PEOPLE WITH INFECTIOUS DISEASES SHOULD NOT USE A SPA OR HOT TUB.

AVERTISSEMENT: LES PERSONNES ATTEINTES DE MALADIES INFECTIEUSES NE DEVRAIENT PAS UTILISER UNE CUVE DE RELAXATION.

WARNING: TO AVOID INJURY EXERCISE CARE WHEN ENTERING OR EXITING THE SPA OR HOT TUB.

AVERTISSEMENT: POUR ÉVITER DES BLESSURES, USER DE PRUDENCE EN ENTRANT DANS UNE CUVE DE RELAXATION ET EN SORTANT.

WARNING: DO NOT USE DRUGS OR ALCOHOL BEFORE OR DURING THE USE OF A SPA OR HOT TUB TO AVOID UNCONSCIOUSNESS AND POSSIBLE DROWNING.

AVERTISSEMENT: POUR ÉVITER L'ÉVANOUISSEMENT ET LA NOYADE ÉVENTUELLE, NE PRENDE NI DROGUE NI ALCOOL AVANT D'UTILISER UNE CUVE DE RELAXATION NI QUAND ON S'Y TROUVE.

WARNING: PREGNANT OR POSSIBLY PREGNANT WOMEN SHOULD CONSULT A PHYSICIAN BEFORE USING A SPA OR HOT TUB.

AVERTISSEMENT: LES FEMMES ENCEINTES, QUE LEUR GROSSESSE SOIT CONFIRMÉE OU NON, DEVRAIENT CONSULTER UN MÉDECIN AVANT D'UTILISER UNE CUVE DE RELAXATION.

WARNING: WATER TEMPERATURE IN EXCESS OF 38°C MAY BE INJURIOUS TO YOUR HEALTH.

AVERTISSEMENT: IL PEUT ÊTRE DANGEREUX POUR LA SANTÉ DE SE PLONGER DANS DE L'EAU A PLUS DE 38°C.

WARNING: BEFORE ENTERING THE SPA OR HOT TUB MEASURE THE WATER TEMPERATURE WITH AN ACCURATE THERMOMETER.

AVERTISSEMENT: AVANT D'UTILISER UNE CUVE DE RELAXATION MESURER LA TEMPÉRATURE DE L'EAU À L'AIDE D'UN THERMOMÈTRE PRÉCIS.

SAFETY INSTRUCTIONS

WARNING: DO NOT USE A SPA OR HOT TUB IMMEDIATELY FOLLOWING STRENUOUS EXERCISE.

AVERTISSEMENT: NE PAS UTILISER UNE CUVE DE RELAXATION IMMÉDIATEMENT APRÈS UN EXERCISE FATIGANT.

WARNING: PROLONGED IMMERSION IN A SPA OR HOT TUB MAY BE INJUROUS TO YOUR HEALTH.

AVERTISSEMENT: L'UTILISATION PROLONGÉE D'UNE CUVE DE RELAXATION PEUT ÊTRE DANGEREUSE POUR LA SANTÉ.

WARNING: DO NOT PERMIT ELECTRIC APPLIANCES (SUCH AS LIGHT, TELEPHONE, RADIO, OR TELEVISION) WITHIN 1.5 M OF THIS SPA OR HOT TUB.

AVERTISSEMENT: NE PAS PLACER D'APPAREIL ÉLECTRIQUE (LUMINAIRE, TÉLÉPHONE, RADIO, TÉLÉVISEUR, ETC) À MOINS DE 1.5 M DE CETTE CUVE DE RELAXATION.

CAUTION: MAINTAIN WATER CHEMISTRY IN ACCORDANCE WITH MANUFACTURER'S INSTRUCTION.

ATTENTION: LA TENEUR DE L'EAU EN MATIÈRES DISSOUTES DOIT ÊTRE CONFORME AUX DIRECTIVES DU FABRICANT.

Hyperthermia occurs when the internal temperature of the body reaches a level several degrees above the normal body temperature of 98.6°F (37°C). The symptoms of hyperthermia include drowsiness, lethargy, and an increase in the internal temperature of the body. The effects of hyperthermia include:

- (a) unawareness of impending hazard;
- (b) failure to perceive heat;
- (c) failure to recognize the need to exit spa;
- (d) physical inability to exit spa;
- (e) fetal damage in pregnant women; and
- (f) unconsciousness and danger of drowning.

WARNING: THE USE OF ALCOHOL OR DRUGS CAN GREATLY INCREASE THE RISK OF FATAL HYPERTHERMIA IN HOT TUBS AND SPAS.

AVERTISSEMENT: LA CONSOMMATION D'ALCOOL OU DE DROGUE AUGMENTE CONSIDÉRABLEMENT LES RISQUES D'HYPERTHERMIE MORTELLE DANS UNE CUVE DE RELAXATION.

SAFETY INSTRUCTIONS

For spas relying on a specific means of egress, such means shall not be removed when the spa is in use.

DANGER – This appliance is not intended for use by persons (including children) with reduced physical, sensory or mental capabilities, or lack of experience and knowledge, unless they have been given supervision or instruction concerning use of the appliance by a person responsible for their safety.

Children should be supervised to ensure that they do not play with the appliance.



Safety graphical symbol ISO 20712-1, WSM002 – Keep children under supervision in the aquatic environment

DANGER – Risk of Accidental Drowning (especially children under 5 years). Caution shall be exercised to prevent unauthorized access to the spa by children. This can be reached by an adult supervisor securing the means of access or installing a safety protection device to the spa. To avoid accidents during spa use, ensure that children are kept under constant adult supervision).

Avoid putting the head under water at all times.

Avoid swallowing spa water.

DANGER – No Diving.



Safety graphical symbol ISO 20712-1, WSP005 – No Diving

REGULATIONS

Below are important requirements that you should be aware of prior to using and operating your spa per European Standard EN 17125:2018.

MEANS OF ACCESS AND SPA ACCESSORIES

All accessories that are supplied shall be safe and compatible with the spa as required by section 4.3 of EN17125. The user can only use accessories exclusively provided by the spa manufacturer (i.e. Master Spas manufactured insulating cover) for safety reasons (section 6.1 d).

Means of access is not provided with the spa. Accessories necessary for means of access must meet European standard EN 17125. The type of means of access to the spa must be considered (ingress and/or egress where not obvious). Access means can be either secured or unsecured. See Accessory Manufacturer Specifications for the following:

- the commercial name or reference;
- an indication of the maximum allowable weight permitted on the means of access;
- illustrations repeating the overall dimensions of the product;
- stepping height and width of the wall, if appropriate for ingress and egress;
- if appropriate, any indication concerning the construction of onsite reinforcement works for installing the means of access;
- the warranty period(s) of the means of access;
- Proper care instructions for winterization.

NOTE: A handrail may be proposed with the means of access in case of use by people with mobility issues.

Consult manufacturer or contractor for proper care during winterization and to review maximum weight allowed. Means of access shall not be used for any purpose besides for spa entry. Stairs used for entry to the spa/swim spa must comply with section 4.6.4 of EN 17125.

A cover lifter, when applicable, should be designed to keep the cover off the ground when in use, to avoid dirt and debris getting on the cover.

ELECTRICAL REQUIREMENTS OF SPA ACCESSORIES

Electrically operated accessories shall comply with electrical safety standards and regulations (national and European). They must be assembled in accordance with the manufacturer's manual. The electrical installation of any material related to the spa and its surroundings shall comply with national requirements.

SAFETY DEVICES

- A safety cover or other safety protection device(s) shall be used, or all doors and windows (where applicable) shall be secured to prevent unauthorized access to the spa.
- Barriers, covers, alarms, or similar safety devices are helpful aids, but they are not substitutes for continuous and competent adult supervision.

SAFETY EQUIPMENT

- It is recommended to keep rescue equipment (e.g. a ring buoy) by the spa (if appropriate).
- Keep a working phone and a list of emergency phone numbers near the spa.

REGULATIONS

SAFE USE OF THE SPA

- Encourage all users especially children to learn how to swim.
- Learn Basic Life Support (Cardiopulmonary Resuscitation - CPR) and refresh this knowledge regularly. This can make a life-saving difference in the event of an emergency.
- Instruct all spa users, including children, what to do in case of an emergency.
- Never dive into any shallow body of water. This can lead to serious injury or death.
- Do not use the spa when using alcohol or medication that may impair the bather's ability to safely use the spa.
- When covers are used, remove them completely from the water surface before entering the spa.
- Protect spa occupants from water related illnesses by advising them to keep the water treated and to practice good hygiene. Consult the water treatment guidelines in the user's manual.
- Store chemicals out of the reach of children.
- Use the signage provided on the spa or within 2 000 mm (78.74 in) of the spa in a prominent visible position.
- Removable ladders, when removed, shall be stored safely where children cannot climb on them.

NON SWIMMERS SAFETY

- Continuous, active, and vigilant supervision of weak swimmers and non-swimmers especially in exercise spas, by a competent adult is required at all times (remembering that children under five years of age are at the highest risk of drowning).
- Designate a competent adult to supervise the spa each time it is being used.
- Weak swimmers or non-swimmers should wear personal protection equipment, especially when using the exercise spa.
- When the spa is not in use, or unsupervised, remove all toys from the spa and its surrounding area to avoid attracting children to the spa.

PERMISSIBLE OPENINGS

Requirements on the size of the accessible openings shall be as follows.

OPENINGS PRESENTING A RISK OF ENTRAPMENT OF FINGERS, TOES, HANDS, FEET:

- If the lowest point of the opening is located up to and including the first 500 mm of the designed water surface, no requirements will apply;
- If the lowest point of the opening is located more than 500 mm below the designed water surface, the requirements of EN 16582-1 (domestic pools) will apply with the following exception: Hydro-massage jets with opening diameters > 8 mm or < 25 mm are also allowed below 500 mm of the designed water depth, when they are installed in designated seating/ lounging areas including foot massage jets and provided with the warning sign with icon below about the risk of finger entrapment.



EN 17125 – Do not put finger in massage jet

- If the depth of penetration is less than 10 mm, no requirements apply.

OPENINGS PRESENTING A RISK OF ENTRAPMENT OF HEAD OR NECK:

If the opening is fully located under the water surface, permissible opening requirements of EN 16582-1 (domestic pools) will apply.

In compliance with EN 17125

REGULATIONS

USE OF NON-WATER TREATMENT CHEMICALS

For chemicals unrelated to water maintenance/treatment (i.e. cleaning products and aromatherapy), only use appropriate chemicals approved by the applicable regulations and the chemicals referenced in this manual.

SPA SURROUNDINGS

Barefoot areas and relaxing areas shall be considered in the cleaning process as well. No cleaning water may flow into the spa or spa water cycle. The dirt and cleaning agents shall be rinsed carefully to drain to surrounding areas away from the spa.

OPERATIONAL ADVICE

- To allow good circulation when the spa purges and filters so that chemically treated water flushes through all plumbing; all jets should be left in their open position, air controls/aeration valves closed and water diverters adjusted to half way (diverting water to all jets).
- Whenever the spa is emptied, the filter(s) should be cleaned (and drained/dried, where applicable).
- In the absence of automated and/or continuous water treatment (measurement and chemical dosage) any manual dosing of chemicals shall not be performed while bathers are present in the spa.
- Where an automatic system is installed, periodic checks are still required as per Water Maintenance instructions in this manual.
- Master Spas recommends fast dissolving chlorine granules (sodium dichlor). It is not recommended that chlorine tablets and a floater be used.

ENERGY EFFICIENCY ADVICE

In order to minimize energy consumption in everyday use of the spa, always use an insulating cover to minimize calorific losses at the water surface (due to evaporation, convection and conduction) when the spa is not in use.

NOTE: The recommended minimum thermal specifications of an insulating cover is 5"-3" thickness taper with 1.25 lb density foam.

COMPLIANCE

Relax and rest assured that your Master Spas manufactured spa has been built with safety in mind. We manufacture our self-contained spas to meet a stringent list of industry standards.

Our spas comply with the following industry standards:

- UL 1563 Standard for Electric Spas, Equipment Assemblies and Associated Equipment
- ICC ISPSC International Swimming Pool & Spa Code
- European Standard EN 17125 for Domestic Spas/Whirlpool Spas/Hot Tubs – Safety Requirements and Test Methods
- VGB Virginia Graeme Baker Pool and Spa Safety Act (Certified by UL to UL 1563)
- ANSI/APSP-6 Standard for Portable Spas
- ANSI/APSP/ICC-14 Standard for Portable Spa Energy Efficiency
- CEC Title 20 Appliance Efficiency Regulation
- CSA C22.2 No. 218.1 Spas, Hot Tubs and Associated Equipment
- CE - EN 60335-2-60 Household and Similar Electrical Appliances – Safety: Particular Requirements for Whirlpool Baths and Whirlpool Spas
- CE - EN 60335-1 Household and Similar Electrical Appliances – Safety: General Requirements
- 93/68/EEC CE Marking Directive
- 2014/35/EU Low Voltage Directive
- 2014/30/EU EMC Directive
- AS1926.3-2010 RC2016
- 2014/53/EU Wireless Directive
- UKCA Electromagnetic Compatibility Regulations 2016
- UKCA Electrical Equipment (Safety) Regulations 2016
- UKCA Radio Equipment Regulations 2017
- UKCA The Restriction of the Use of Certain Hazardous Substances in Electrical and Electronic Equipment Regulations 2012
- EU REACH Compliant



VGB SUCTION SAFETY & MAINTENANCE INSTRUCTIONS

VGB 2008:

WARNING



Read and follow all instructions in this manual and on the suction fitting. Failure to follow instructions can cause severe injury and/or death.



Failure to remove pressure test plugs and/or plugs used in winterization of the spa/swim spa from the suction outlets can result in an increased potential for suction entrapment.



Suction outlet components have a finite life. The cover/grate should be inspected frequently and replaced at least every seven years, or if found to be damaged, broken, cracked, missing, or not securely attached.



If the fitting is missing or broken, replace with a fitting of equivalent rating or higher. Use of a lower rated suction fitting could result in entrapment of the body which could result in serious injury including drowning.



Do not use or operate spa/swim spa if this suction fitting is missing, broken or not secured per instructions. The suction fitting is intended to prevent entrapment of the body. Use of the spa/swim spa with a missing, broken or improperly secured suction grate may result in serious personal injury including drowning.



When the spa/swim spa is in operation, suction is created at this fitting. Users of the spa/swim spa must be instructed not to come in contact with this fitting in such a way as to block its orifice. If a user of the spa/swim spa blocks this fitting with his/her body, serious personal injury or drowning may occur.

IMPORTANT SAFETY INSTRUCTIONS



WARNING - SUCTION ENTRAPMENT HAZARD

Suction in suction outlets and/or suction outlet covers which are damaged, broken, cracked, missing, or unsecured can cause severe injury and/or death due to the following entrapment hazards:

Hair Entrapment: Hair can become entangled in suction outlet cover.

Limb Entrapment: A limb inserted into an opening of a suction outlet sump/fitting or suction outlet cover that is damaged, broken, cracked, missing, or not securely attached can result in a mechanical bind or swelling of the limb.

Body Suction Entrapment: A negative pressure applied to a large portion of the body or limbs can result in an entrapment.

Evisceration / Disembowelment Entrapment: A negative pressure applied directly to the intestines through an unprotected suction outlet sump or suction outlet cover which is damaged, broken, cracked, missing, or unsecured can result in evisceration/disembowelment entrapment.

Mechanical Entrapment: There is potential for jewelry, swimsuit, hair decorations, finger, toe, or knuckle to be caught in an opening of a suction outlet cover resulting in mechanical entrapment.

VGB SUCTION SAFETY & MAINTENANCE INSTRUCTIONS

TO REDUCE THE RISK OF ENTRAPMENT HAZARDS:

- Never use a spa/swim spa if any suction outlet component is damaged, broken, cracked, missing, or not securely attached.
- Replace damaged, broken, cracked, missing, or not securely attached suction outlet components immediately.
- It is recommended that suction components be inspected at least monthly.
- Replace the suction within 7 years from the installation date. Contact your dealer or local service center for quoting and scheduling this required maintenance. This is a mandated regulation and is not part of nor covered by the spa/swim spa warranty.

NOTE: Always review entire safety and maintenance information before beginning maintenance. Contact Master Spas for Suction Installation information for complete suction assembly replacement.

GLOSSARY OF SPA TERMINOLOGY

Your new spa features a variety of jets. All jets, regardless of style, return the water to the spa. Air is mixed with the water by using the air controls (if equipped) creating a vigorous massage. Water flow is adjusted by simply turning the outer face of most jets. Your spa may have a combination of pulsating, rotating, dual pulsating and directional adjustable jets. Here are some terms and definitions to help get you acquainted with your spa.

1. THERAPY JETS

Located throughout the seats of the spa to offer a variety of therapy combinations.

2. NECK JETS (if equipped)

Located above the normal water level to provide massaging action to the back of the neck.

3. SHOULDER JETS (if equipped)

Located above the normal water level to provide massaging action to the shoulders.

4. MASTER BLASTER® FOOT THERAPY JET (if equipped)

Large jet with several fixed nozzles located in the bottom of the spa near the floor to provide excellent massage to the feet.

5. JET DIVERTER VALVE* (if equipped)

Located on the top flange of the spa, this large valve physically diverts the flow of water from one group of jets to another. Be sure that no sand or particles are brought into the spa as they will cause the diverter to seize up. It is best to turn the diverter valve only when the pump is turned off.

6. WATER FEATURE VALVE* (if equipped)

Located on the top flange of the spa, this smaller valve adjusts water flow to the waterfalls and/or water features in your spa.

NOTE: When the spa is not in use, this valve should be turned mostly shut (not completely shut) to prevent the water features from allowing water to hit the cover while it is closed. If left mostly open, water may hit the cover and possibly run out of the spa causing water loss.



7. 3-WAY DIVERTER JET* (if equipped, Getaway Hot Tubs)

This large jet can be turned 180° to 3 different points and diverts the flow of water from one group of jets to another. With the pump turned off, twist the face of this jet 1/4 turn at a time clockwise or counterclockwise to adjust.

8. AIR CONTROL VALVE*

These smaller valves are located around the top of your spa. You may increase or decrease the force of your jets by opening or closing the air control valves. Each air control valve will typically function 1 to 2 groups or seats of jets in the spa. When not in use the air controls should be kept in the closed position as the air being introduced into the water can tend to cool the water and increase the dissipation rate of sanitizer levels.

***NOTE:** See Pump Diagrams in the back of this manual for location of valves, controls, and jets.

GLOSSARY OF SPA TERMINOLOGY

9. TOPSIDE CONTROL PANEL

You may safely control spa functions from inside or outside your spa using the Topside Control Panel. This panel is used to control the water temperature, pumps, the spa light, automatic filtration cycles and other advanced functions. The digital display will give you a constant temperature readout and will notify you in case of certain malfunctions. Several user programmable functions are also available.

10. PERSONAL REMOTE CONTROL* (if equipped)

Select spa models may have an additional remote which allows the user to control the jet therapy while remaining in the seat (if applicable). By pressing the control one time, you will activate the pump. Press again for high speed and again to turn it off.

11. EQUIPMENT ACCESS PANEL

This is the skirt panel located below the Topside Control Panel. This area houses the majority of components responsible for the spas operation. These components include the pumps, heater, spa control system, ozonator (if equipped), and LED light system (if equipped). Pump and equipment placement may vary by model.

12. ACCESS PANELS

These are the skirt panels located around all four sides of the spa. All of the skirt panels are removable should service be required. Master Spas recommends at least 3 feet of access be provided around the spa.

13. FILTER LID

This lid fits over the filter area and weir gate to cover the filters. Remove filter lid to access filters for maintenance. For models equipped with a telescoping filter housing, simply lift up to remove this floating assembly to access the filter. At low speed water flow or when the filtering/heating pump is off, the telescoping part of the filter assembly will float at or near the waterline. At high speed water flow, it will be drawn downward. See Accessing Filters in the Regular Maintenance Procedures section for detailed instructions on filter assemblies.

14. WEIR GATE

The weir gate is the horizontal door located in front of the filters that helps keep debris trapped in the filter area.

15. SPA CONTROL SYSTEM

This houses the wiring and electrical components necessary to operate the spa.

16. SPA HEATER

This is an electric heater housed in a stainless steel tube. It is thermostatically controlled and equipped with high-limit temperature safety shut-off sensors.

***NOTE:** See Pump Diagrams in the back of this manual for location of valves, controls, and jets.

GLOSSARY OF SPA TERMINOLOGY



Slice Valve and Pump Union

17. SLICE VALVES

These valves are used by service personnel to shut off water to the heating system (heater and pump plumbed to the heater) so that the spa water does not need to be drained if the spa requires service to the heating system (varies by model).

NOTE: Slice valves must be completely open during normal operations.

18. MAIN THERAPY PUMP

This produces water flow through the main jets in the spa. The first pump may be operated on two speeds (varies by model). Low speed (if applicable) will produce efficient water circulation during filtration, heating of the spa water, and gentle jet action. High speed provides maximum jet action. The main pump is controlled by the “Jets” or “Jets 1” button on the Topside Control Panel.

19. SECONDARY THERAPY PUMP (if equipped)

This produces water flow through 1 to 2 groups or seats of jets in the spa. The second pump operates similar to the main pump and is controlled by the “Jets 2” or “Aux” button on the Topside Control Panel.

20. THIRD THERAPY PUMP (if equipped)

This produces water flow through 1 to 2 groups or seats of jets in the spa. This is controlled by the “Jets 3” button on the Topside Control Panel.

21. CIRCULATION PUMP (if equipped)

This produces water flow through the heater in the spa and provides the water flow necessary to actuate the ozone injector. This energy efficient pump typically runs 24 hours for efficient filtration and heating.

22. PUMP UNION

This connects the plumbing and pump together. These are used to help relieve possible pump air locks or for service personnel to easily service the pumps.

23. HEATER UNION

These are used by service personnel to easily service the heater.

THE ADVANTAGES OF ECOPUR® CHARGE

ECOPUR® CHARGE MASTER CORE TECHNOLOGY

The EcoPur® Charge* is made from Master Spa's patented filtration fabric. This fabric is wound tightly into a nautilus master core, creating a catalytic cell. The nautilus fabric cell is encased by a unique "spring core" that allows for maximum flow and water "charging". As water comes in contact with the EcoPur® Charge Master Core, a chemical reaction causes zinc and copper hydroxides to form in controlled amounts. Like Mother Nature, when controlled releases of copper and zinc oxides are carried into the filtered water, they kill bacteria and provide hostile conditions for algae and fungal growth. Using EcoPur® Charge helps reduce the amount of chemicals needed, therefore safeguarding the hot tub's plumbing and equipment because pipes are protected against the corrosive effects of chlorine. EcoPur® Charge Master Core Technology is another exclusive design by Master Spas.

FEATURES

- Releases Sanitizing Copper & Zinc Oxides
- Reduces Water Soluble Heavy Metals
- Controls Scale, Bacteria and Algae
- Safeguards the Spa's Plumbing
- Reduces Use of Chemicals
- Helps Prevent Damage to Swimwear



*PATENTS PENDING

THE ADVANTAGES OF ECOPUR® CHARGE

ECOPUR® CHARGE INSTALLATION

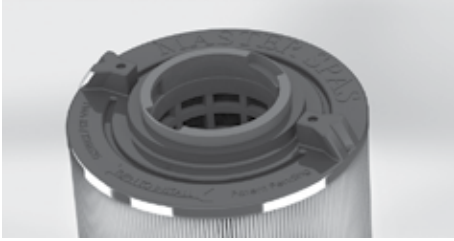

Master Spas Outer Filter*



EcoPur® Charge*

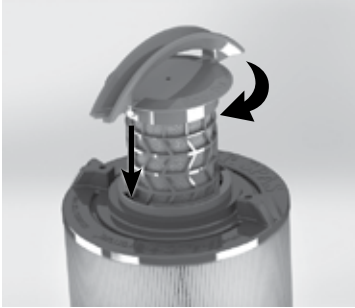

Turn Clockwise to Lock

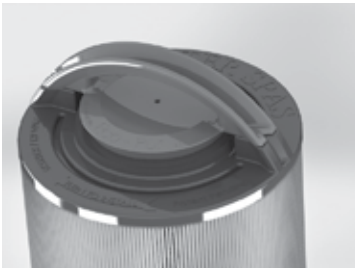

STEPS FOR INSTALLATION

1. Insert EcoPur® Charge into outer filter.
2. Twist EcoPur® Charge clockwise to lock in place while holding on to outer filter. When snapped in to locked position, EcoPur® Charge handle aligns with molded points on outer filter.

NOTE: EcoPur® Charge should be replaced every 6 months. Initial snap in fit of inner EcoPur® Charge to outer filter may be tight, especially if both are new.



*PATENTS PENDING

WATER CHEMISTRY TERMS YOU SHOULD KNOW

EN 17125

Before jumping into Water Maintenance, here are some terms to help you.

- 1. PARTS PER MILLION (PPM):** This is a form of measurement used in most pool or spa chemical readings. Best described as any one million like items of equal size and make up, next to one unlike item, but of equal size. This would be one part per million.
- 2. TOTAL ALKALINITY:** Measures substances in your water such as hydroxides, carbonates and bicarbonates. When at the proper levels, these elements keep your water from clouding and growing bacteria, as well as prevent the inner workings of your hot tub from deteriorating or forming scale. TA also helps to stabilize pH. The higher the TA level (as long as it is within the recommended range), the less likely the pH is to change. With low alkalinity, the pH will fluctuate and be harder to control. With high alkalinity, it becomes extremely difficult to change the pH.
- 3. PH OR POTENTIAL HYDROGEN:** This indicates the acidity or basicity of the water. The goal is to have a neutral, stable pH to prevent spa damage and unhealthy conditions. Low pH levels can corrode metals, etch or stain fiberglass or acrylic, cause unsanitary conditions that irritate the eyes or skin and destruct the total alkalinity of the water. High pH can cause cloudy water, eye or skin irritation, scale formation and poor chlorine or bromine efficiency. Note that the chemicals you are using to sanitize and clean your hot tub can also lower or raise the pH level in the water. Unfortunately, there are lots of variables to preventing high pH in your hot tub.
- 4. SHOCKING:** By shocking the water in your hot tub, you remove organic compounds from the water, kill bacteria, remove bromamines or chloramines and reactivate the bromides in the spa for cleaner water. You should shock your water once a week, after heavy bather use or any time free chlorine levels test lower than total chlorine levels. To do this, either add oxidizer/non-chlorine shock to burn off the chloramines or add extra chlorine to raise the chlorine level. Oxidizer/non-chlorine shock acts by releasing oxygen in the water, which serves a similar function as chlorine. An advantage to using this type of shock is that the water is safe to enter after 15 minutes of the application and excessive sanitizer (chlorine) levels do not occur. However, an oxidizer/non-chlorine shock doesn't disinfect the water for bacteria. If you use chlorine to shock, you must wait until the total chlorine reading is at a level safe to reenter the water.
- 5. SEQUESTERING:** This can be defined as the ability to form a chemical complex which remains in solution, despite the presence of a precipitating agent (i.e. calcium and metals). If the minerals and metals in water are not sequestered, they can cause a reaction, turning the water brown, red, orange or green depending on the minerals and metals present in your water. It is important to add a sequestering agent when adding water to your spa and even on a regular basis (if bottle instructions recommend doing so). Common names for sequestering chemicals are: minquest, stain and scale control, metal-x, spa defender, spa metal gone, etc.
- 6. FILTRATION:** Filters are necessary to remove particles of dust, dirt, algae, etc., that are continuously entering the water. If the spa is not operated long enough each day for the filter to do a proper job, this puts a burden on the chemicals, causing extra expense. Filtration time will depend on the water capacity, pump and filter size and, of course, bather load. Spare filter cartridges should be kept on hand to make it easy to frequently clean the cartridge without the need for a long shut down. This will also allow the cartridge to dry out between usages, which will increase the cartridge life span as much as twice. Replace the cartridge when the pleats begin to deteriorate. Cartridge cleaning should be done a minimum of once a month. More often with a heavy bather load. See Cleaning Your Filter Elements in the Regular Maintenance section.

WATER CHEMISTRY TERMS YOU SHOULD KNOW

- 7. SANITIZERS:** Germs and bacteria enter the water from the environment and the human body; a sanitizer keeps the water balanced and safe to use. Either chlorine or bromine can be used as a sanitizer to create a healthy water environment.
- A. Chlorine:
1. Only one type is approved for spa use. Sodium dichlor which is granular, fast dissolving and pH neutral chlorine.
 2. Chlorine is an immediate sanitizer and will be added as needed to maintain free chlorine levels.
- B. Bromine
1. Two types of tablets:
 - a. Hydrotech
 - b. Lonza
 2. Bromine is a slow dissolve chemical and may take a few days to develop a reserve or reading in the water.
- NOTE:** Bromine use is not recommended with EcoPur® filters as it can hinder being able to maintain proper reserve/residual levels for maintaining sanitary conditions.
- WARNING:** SoftTread mats are not compatible with bromine and will result in unwarranted deterioration of the material. Do not use bromine if your spa is equipped with these mats.
- 8. TOTAL DISSOLVED SOLIDS (TDS):** Materials that have been dissolved by the water, i.e. like what happens when you put sugar in coffee or tea.
- 9. USEFUL LIFE OF WATER (IN DAYS):** Water should be drained at least once every 180 days. Useful life may vary by usage and bather load.
- 10. DEFOAMER:** A chemical used to temporarily reduce foaming. Causes of foaming include body oils, cosmetics, lotions, surface cleaners, high pH or algae, as well as other organic materials. Low levels of calcium or sanitizer can also cause increased foaming. Note that you may need to physically remove the foam and/or drain all or part your water to remove or dilute the causes of the foam.
- 11. CALCIUM HARDNESS:** This measurement tells you how much magnesium and calcium are in your water. However, calcium hardness can react with all of the chemicals, bacteria, dirt and other substances that your water dissolves and get thrown out of balance. Just like the other elements, calcium levels must remain balanced and need to be monitored or you run the risk of metal deterioration, water foaming or clouding and scale formation at the surface of your water.
- NOTE:** Always leave spa cover open for 15 minutes after adding chemicals to prevent the off gas from damaging your spa cover, spa pillows, stainless steel hardware and other critical parts.
- 12. BIOFILM:** This is any group of microorganisms in which cells stick to each other and often these cells adhere to a surface (ie. spa plumbing and shell). Biofilm can occur over time during the use of your spa.

WHY ARE CHEMICALS IMPORTANT IN A SPA

1. EVAPORATION:

As water evaporates, only pure water evaporates, leaving the salts, minerals, metals, and any unused chemicals behind. Adding water adds more salts, minerals, and metals. In time, the water can become saturated with these dissolved solids and can cause stains or scale to form on the walls of the spa or a scale build up inside the equipment. Colored or cloudy water and possible corrosion of plumbing and fittings may also occur.

2. HEAT:

Heat causes much quicker evaporation and also will cause minerals and metals to precipitate out of solution.

3. AIR:

Dust and other airborne contaminants are introduced into the spa.

4. ENVIRONMENT:

The environment surrounding the spa can also impact the water quality. Items such as pollen, grass, sand, dirt, lawn fertilizer, airborne dust, insects, leaves, and pets can all affect the water quality of the spa.

5. BATHERS:

As the spa is used, bathers introduce contaminants to the water. Increased bather load, length of use and frequency will increase the amounts of contaminants added in to the water.

NOTE: The maintenance routines set forth in this manual may need to be adjusted depending on bather load and how much the spa is being used.

WATER MAINTENANCE – RECOMMENDED RANGES

WATER CHEMISTRY GUIDE

Before treating your water, refer to the Model Specifications section of this manual for the correct gallons of your spa, to ensure you are adding the correct amount of chemicals. The concentration of active ingredients in spa chemicals varies by manufacturer, so always consult chemical manufacturer's instructions. When adding spa chemicals, always spread them across the surface of the water while the pumps are running. See chart below for recommended ranges.

BS EN 17125:2018

| PARAMETER | VALUE ^A |
|---|--|
| Water Clarity | Clear view of the bottom |
| Color of Water | No color should be observed ^{b, c} |
| Turbidity in FNU/NTU | max. 1,5 (preferably less than 0,5) |
| Nitrate concentration above that of fill water (in mg/l) | max. difference of 20 compared to the fill water concentration |
| Total organic carbon (TOC) (in mg/l) ^d | max. 4,0 |
| Redox potential against Ag/AgCl 3,5 M KCl in mV | min. 650 |
| pH value ^{e, f} | 6,8 to 7,6 |
| Free active chlorine (without cyanuric acid) (in mg/l) | 0,3 to 1,5 ^g |
| Free chlorine used in combination with cyanuric acid (in mg/l) | 1,0 to 4,0 ^g |
| Cyanuric acid (in mg/l) | max. 100 ^h |
| Combined chlorine (in mg/l) | max 0,5 ⁱ (preferably close to 0,0 mg/l) |
| Bromine (in mg/l) | 2,0 to 4,0 ^g |

When using alternative/additional disinfectants other appropriate parameters may be considered.

^a Consult national regulations and guidelines for any deviations.

^b Natural water sources may introduce water colouration.

^c Intentional water colouration is excluded.

^d When using organic compounds this value may be higher.

^e Subject to the flocculant(s) used (if any).

^f When pH is greater than 7,5 the free active chlorine is less than 50 %.

^g Temporary exceeding due to manual dosage and low water volume to user ratio is acceptable, provided the health of the user is not compromised.

^h If national regulations allow > 100 mg/l then a suitable treatment should be applied (e.g. dilution).

ⁱ If national regulations allow > 0,5 then a suitable treatment should be applied (e.g. dilution)

NOTE: The Indicative physical and chemical parameters when using chlorine disinfectant outlined in this manual are specified to comply per EU regulation (BS EN 17125:2018). Regulatory agencies in countries outside of the EU may require different values than what is outlined here. If the spa is installed in a country outside of the EU, check with your local regulatory body for recommended chemical levels in your area. Improper use of chemicals may result in unsanitary and unsafe water conditions as well as unwarranted discoloration, degradation, damage and other imperfections of the spa surface and components.

 **WATCH HOW-TO VIDEOS:** masterspas.com/video-tutorials

START UP STEPS

1. Your spa should be filled with fresh tap water using a Pre-filter, which can be obtained from your local Master Spas dealer. This Pre-filter will help remove many of the minerals existing in the water, which will make adjusting the water balance easier after a new fill. Never use more than 50% softened water when filling the spa.
2. During the initial filling of the spa, add a sequestering agent to combat suspended minerals in the water. The agents are sold under many different names such as Mineral Clear or Metal Protect. Always follow the instructions listed on the bottle and allow water to circulate and filter for at least 30 minutes (or per bottle recommendations) before adding any other chemicals.
3. Test water for pH, total Alkalinity, and Calcium hardness. There are two different methods you can use to test your water.

TEST STRIPS: The pads on these thin strips react by changing colors when you dip them in the hot tub water. To avoid faulty test results, use care when removing a testing strip from the packaging. Open the package and shake one strip out into your hand, avoiding contact if possible with the remaining strips. Seal the container immediately so the remaining strips are not exposed to moisture. Dip the test strip into the water and follow the instructions supplied with test strips as instructions may vary. Note the colors on your testing strip and compare these to the key found on the packaging to determine whether elements are neutral, too high or too low.

TESTING KIT: When using a testing kit, you will be examining an actual water sample from your hot tub, rather than a strip. Be careful to follow the instructions on your kit, filling the container to the appropriate level and then dropping the instructed liquid into the container. Compare the new color of your water to the key provided with the kit to determine how to proceed. Depending on which kit you purchase, it can test for each one of these elements: total alkalinity, pH, chlorine, bromine and calcium hardness.

4. Adjust pH and total Alkalinity (TA) utilizing the directions on the chemical bottles. Wait 15 minutes, test and adjust if necessary.
5. It may be necessary to retest and add additional chemicals to get to the proper levels.
6. Add concentrated chlorinating granules (sodium Dichlor-s-triazinetreone) on initial start up to begin sanitizing the spa water, according to directions on chemical bottle. Bathers should not enter the spa until the chlorine drops to a safe level, refer to Water Chemistry Guide in this section. It is important not to add the chlorinating granules until the pH, alkalinity and calcium hardness have been adjusted to their proper levels.

NOTE: See the Model Specifications section of this manual for the correct gallons of your spa, to ensure you are adding the correct amount of chemicals. When adding chlorine or non-chlorine shock/oxidizer always spread it across the water while the pumps are running. The concentration of active ingredients in spa chemicals varies by manufacturer.



WATCH HOW-TO VIDEOS:
masterspas.com/video-tutorials

WATER MAINTENANCE – SCHEDULE

EN 17125

▶ **WATCH HOW-TO VIDEOS:** masterspas.com/video-tutorials

BEFORE EACH USE

Test the spa water for proper pH and sanitation levels. Adjust accordingly to the proper levels outlined in the Water Chemistry Guide, found in the Water Maintenance – Recommended Ranges section. Appropriate levels should be present before use of the spa. Bathers should not enter the spa if the chlorine levels are outside of the safe, recommended ranges.

AFTER EACH USE

Test water and treat accordingly to maintain proper pH and free chlorine levels for continued sanitary conditions after use. The amount of people using the spa (and duration of use) will deplete chlorine levels and can cause free chlorine to test below total chlorine, resulting in a more frequent need to use an oxidizer/non-chlorine shock treatment.

3 TIMES A WEEK

Test the water using chemical test strips. Adjust sanitizer, pH and Alkalinity accordingly, following directions on the chemical manufacturer's bottle. If free chlorine level measures less than total chlorine level, additional non-chlorine shock/oxidizer treatment is necessary.

ONCE A MONTH

Soak your regular filter elements overnight in a container with spa Filter Cleaner and then rinse with clean water. For best results, allow the filter to dry before re-inserting. (The EcoPur® element should never be cleaned in a filter cleaner. Just rinse with water.) When cleaning filters, be sure to never have the pumps (including the circulation pump) running without the filters in place. Failure to do so may result in debris being drawn into the pumps causing unwarranted damage. See Cleaning Your Filter Elements in the Maintenance section of this manual for more information.

EVERY 180 DAYS

Drain and refill your spa with fresh water, install a new EcoPur® element, clean the regular filter, and repeat start up procedure. The regular filter should be replaced at least once every year. Over time and bather use, biofilm buildup can occur. Chemical products are available to help remove biofilm and should be used periodically before draining.

AS NEEDED

If the water looks hazy, make sure pH is in the proper range and treat with chlorinating granules to maintain free chlorine levels. Treat with non-chlorine shock (oxidizer shock) if free chlorine is less than total chlorine. Always refer to the chemical manufacturer's dosage recommendations listed on the container. Free chlorine levels should be maintained per the Water Chemistry Guide.

A defoamer may be used when excessive foaming occurs. Over use of a defoamer will result in cloudy, milky water. These are general recommendations for water maintenance that may vary by usage and bather load. Depending on bather load and frequency of use, drain and refill times may vary as well as the frequency of cleaning your filters.

USE ONLY SPA CHEMICALS

Do not use chemicals designed for use in swimming pools. With a spa you are working with a small volume of hot water compared to a large volume of relatively cool water in a swimming pool. Because of this, chemicals will have a shorter life span and bacteria can grow more quickly than in a swimming pool. A spa is less forgiving than a pool and requires that whatever is put into it have a pH as close to neutral as possible. That is why only chemicals made for spas should be used. Always refer to the chemical manufacturer's dosage recommendations listed on the container.

WATER MAINTENANCE – TROUBLESHOOTING GUIDE

EN 17125

▶ WATCH HOW-TO VIDEOS: masterspas.com/video-tutorials

| PROBLEM | POSSIBLE CAUSES | HOW TO FIX IT |
|-------------------------------------|--|---|
| CHLORINE ODOR | Excessive chlorine | Shock water with oxidizer/non-chlorine shock treatment |
| | Low pH | Adjust pH if necessary |
| WATER ODOR | Low levels of sanitizer | Adjust sanitizer level with chlorinating granules |
| | pH out of range | Adjust pH if necessary |
| | Bacteria or algae growth | If sanitizer has already been adjusted, it may be necessary to perform a system flush |
| CLOUDY WATER | Dirty filters or inadequate filtration | Clean filters with filter cleaner and adjust filtration |
| | Unbalanced water chemistry | Test and adjust chemistry levels |
| | Old water | Drain, clean inner shell and refill with filtered water |
| CLOUDY AND GREEN WATER | Total alkalinity levels are low | Use a pH increaser |
| | Sanitizer levels are low | Apply oxidizer/non-chlorine shock treatment and adjust sanitizer |
| CLEAR GREEN WATER | High iron or copper content | Use a sequestering agent |
| | Sanitizer levels are low | Apply oxidizer/non-chlorine shock treatment |
| BROWN WATER | High iron or manganese level | Use a sequestering agent |
| FOAMING | High levels of body oils, lotions, soap, etc. | Add small amount of defoamer, an enzyme product and check water chemistry |
| | Low calcium hardness | Use a calcium hardness increaser |
| | Unbalanced water chemistry | Test and adjust chemistry levels |
| EYE OR SKIN IRRITATION | Unsanitary water | Adjust water chemistry according to testing results |
| | Total chlorine level above 5 ppm | Apply oxidizer/non-chlorine shock treatment |
| | Poor sanitizer/pH levels | Adjust pH level as necessary |
| SCUM DEPOSITS AT WATERLINE | Body oils and dirt | Use multi-purpose cleaner to clean spa surface and add enzyme product to spa water |
| CHALKY, WHITE SCALE DEPOSITS | Minerals present in the water and lack of sequestering agent use | When tub is drained, use a multi-purpose cleaner or white vinegar and scrub with a soft cloth |
| PITTING OF METAL FIXTURES | Low pH or total alkalinity | Check water chemistry and adjust |

NOTE: Please refer to the Water Maintenance - Recommended Ranges section to review recommended chemical levels.

REGULAR MAINTENANCE PROCEDURES

EN 17125

▶ WATCH HOW-TO VIDEOS: masterspas.com/video-tutorials

NOTE: These maintenance procedures are the responsibility of the spa owner to perform. These procedures are not covered by the spa warranty.

DRAINING YOUR SPA

Before you start draining your spa, be sure all power is turned off to it. Your spa requires periodic draining and cleaning to ensure a safe, healthy environment. It is recommended that you clean your spa at least every 180 days or as necessary. Heavy bather load will require draining and cleaning it more often. Draining times will vary by model when using the equipped internal drain assembly. A sump pump may also be used to expedite the draining of the spa.

NOTE: If your hot tub required multiple electrical services, be sure to turn off breakers for all services powering the spa equipment. See model specifications and appropriate electrical requirements for your model or contact your electrician if you are not familiar with how your electrical was installed. A breaker or power cut off should always be within line of sight.

Caution and careful planning should be taken if draining in freezing temperatures to ensure the process is performed quickly (by use of a submersible pump) and that the water is either refilled quickly again or winterization steps are immediately performed. Try to plan your normal draining maintenance during times when temperatures are above freezing. Excess water in the plumbing can freeze in a short time frame depending on temperatures and conditions. Water freezing within plumbing and components can result in freeze damage which is not warranted.

STEPS FOR USING THE EQUIPPED INTERNAL DRAIN

The spas are equipped with a drain assembly which can be located on the front side of the spa behind the skirt (same side as the topside control panel or where most of the spa equipment is located). The drain will be located in the equipment area behind the front skirt panel (Figure 1).



Figure 1



Figure 1.1

1. Remove the front skirt panel by removing its panel screws. The drain will be located inside the equipment bay (see Figure 1 & Figure 1.1).
2. To start the flow of water with this drain assembly; remove the cap, twist the face counterclockwise and pull out slightly on the face. A garden hose can be attached to the end of the drain assembly, if so desired.

NOTE: With the cap removed from the drain; water may drip or weep from the drain. This is normal. Be sure that the steps are followed in reverse order when draining is finished. Make sure that the drain cap is reattached and the valve is put back to the fully closed position so that there is no water leaking from the drain assembly.

STEPS FOR USING A SUMP PUMP*

1. Carefully lower submersible pump with hose connected into the bottom of spa, taking care not scratch or gouge your spa shell.
2. Run the discharge end of the hose from your submersible pump to a desired location several feet away from your spa, where the water will drain away from foundation that the spa is resting on.
3. Plug in/turn on your submersible pump.
4. Turn off/disconnect your submersible pump once it is no longer able to suck up any further water (indicated by a suctioning sound and water no longer coming out of the drainage hose). If you plan to fully wipe down and clean your entire spa shell, a shop vac can be used to remove the remaining small pockets of water in the spa.

*Sump Pump is not provided with spa.

REGULAR MAINTENANCE PROCEDURES

▶ WATCH HOW-TO VIDEOS: masterspas.com/video-tutorials

NOTE: These maintenance procedures are the responsibility of the spa owner to perform. These procedures are not covered by the spa warranty.

SPA SURFACE CARE

- During use, always remove debris and pollutants that have settled in the water or built up on the spa surfaces as it occurs. These pollutants can cause growth of bacteria, algae, fungus or biofilm if left on the spa surface and potentially cause stains.
- Clean the spa shell, jets and other controls with a soft cloth and spa shell cleaner to help remove residue and buildup on the shell surface. For any remaining buildup, white vinegar or mild scale remover product may be necessary to use with a soft cloth for removal. Consult with your local Master Spas dealer for proper spa cleaning products.
- Rinse the cleaned surfaces with fresh water from your garden hose and wipe with a soft cloth as doing so will help to remove residual cleaning agents (as some may cause foaming to occur in the water once spa is refilled).
- Always use an approved insulating spa cover by Master Spas to cover your spa when not in use, especially in outdoor installations where the spa is exposed to weather conditions and sun. Constant, prolonged exposure and use of unapproved or non-insulating spa cover can result in damage to spa surface which would not be warranted.

CARE OF YOUR SPA PILLOWS

- Your spa pillows should be rinsed periodically to remove chemical residue. This helps improve pillow lifespan and slows down deterioration of the pillows (i.e. discoloring, becoming stiff and flaking of the material).
- If the spa will not be used for a period of time, the pillows could be removed and rinsed to prolong their life.

NOTE: Do not cover the spa for 15 minutes after adding chemicals as the off gas can cause damage.

CARE OF YOUR SPA CABINET

The spa cabinet is made from a UV resistant material. The cabinet requires only periodic cleaning with a stream of water from a garden hose. If necessary, use mild soap and water with soft cloth to wipe down cabinet surface. Rinse thoroughly.

REGULAR MAINTENANCE PROCEDURES

ACCESSING FILTERS

Filter Weir with Top Access



Remove Filter Lid



Turn Filters Counter-clockwise to Remove

Vane Teleweir Filter Housing



Pull Up to Remove Floater Assembly



Turn Filters Counter-clockwise to Remove

Telescoping Filter Housing



Twist Lock Ring Counter-clockwise to Remove Floater



Remove Basket



Turn Filters Counter-clockwise to Remove

Filter Weir with Slide Off Access



Slide Faceplate Up to Remove



Turn Filters Counter-clockwise to Remove

REGULAR MAINTENANCE PROCEDURES

▶ WATCH HOW-TO VIDEOS: masterspas.com/video-tutorials

NOTE: These maintenance procedures are the responsibility of the spa owner to perform. These procedures are not covered by the spa warranty.

Vane Skimmer Filter Housing



Remove Top Cap by Gently Lifting



Lift Up and Remove Basket



Turn Filters Counter-clockwise to Remove

CLEANING YOUR FILTER ELEMENTS

The filter elements are one of the most important components of your spa. Not only are they essential for clean water; they also extend the life of the spa equipment and help avoid unnecessary water changes and re-heating. Your filter elements should be cleaned on a regular basis, at least once a month on average with normal usage. With heavy use, poor water quality and/or high dissolved solid content in water; the filters may need to be cleaned more often. It recommended to allow filter elements to fully dry after cleaning. For this reason, it is ideal to have a spare set of filters on hand for filter cleaning intervals.

1. Turn off the spa before servicing filters. Never leave to the spa running when removing the filters. Debris can be pulled into the plumbing system and cause unwarranted damage.
2. Remove filter element(s).
3. With a garden hose, spray each element under pressure. Monthly, the standard filter elements should be soaked in a filter cleaner. Do not soak EcoPur® element in a filter cleaner. The EcoPur® element should only be rinsed with fresh, clean water if necessary. Check with your Master Spas dealer for details on cleaning and/or filter replacement recommendations.
4. The EcoPur® element should be replaced every 6 months. The standard filter should be cleaned regularly and will typically last approximately 1 year. Bather load, usage and water quality will effect the longevity of the filters and require more frequent cleaning or replacement.



CLEANING JETS

The majority of jets in your spa can individually be turned on/off. If any of these jets become hard to turn, it will be necessary to remove the jet to clean it as grit/sand and mineral deposit may be present.

The jets in your spa can be removed for cleaning by turning them counter-clockwise until they release and then pulling out the jet.

TO CLEAN JETS: Place the jet(s) in a container, fully immerse in white vinegar. Let the jet(s) soak overnight and then rinse with water. Reinstall the jet(s). It may be necessary to clean grit and deposits from the white jet body (mounted in the spa shell) by using a small bristled brush.

REGULAR MAINTENANCE PROCEDURES

NOTE: These maintenance procedures are the responsibility of the spa owner to perform. These procedures are not covered by the spa warranty.

CARE OF LAMINAR FLOW JETS:

In order to keep your Laminar Flow Jets operating properly, follow these steps:

1. Turn off Laminar Flow Jets.

2. Remove outer ring by turning face counter-clockwise while pulling on it.



3. Either the whole Laminar Flow Jet Assembly pops out: Rinse it out and inspect it.

Or, if only the outer ring comes off: Remove internal Jet insert with a pair of needle nose pliers and inspect it.



OR



4. Clean plastic diffuser at the back of the Jet insert or Laminar Flow Jet Assembly so all holes are free of debris.

5. Reinstall Jet insert or assembly and outer ring by pushing it in and turning it clockwise until it stops.

NOTE: To prevent premature failure of your spa cover and the possibility of water running out of the spa off the bottom of the cover, always turn Laminar Flow Jets down so that they do not hit the cover when the cover is closed. You do not want to completely turn jets off. Doing so may cause a build up of stagnant water in the water line if not used often.



EN 17125, Do not put finger in massage jet

REGULAR MAINTENANCE PROCEDURES

NOTE: These maintenance procedures are the responsibility of the spa owner to perform. These procedures are not covered by the spa warranty.

CLEANING DIVERTER VALVES

Mineral deposits, grit and sand may get into the internal parts of the diverter valves over time. The diverter valves may become difficult to turn or not turn at all.

CAUTION – TURN OFF SPA BEFORE PROCEEDING WITH THIS MAINTENANCE.



FOR THESE STYLES OF HANDLES, FOLLOW THE STEPS BELOW:

1. Remove the handle from the top of diverter valve by grasping the handle and pulling up with a rocking motion.
2. Turn the cap piece counter-clockwise. It may be necessary to put a clean towel over the cap and turn it with a wrench.
3. Once loose, the cap, internal rotor assembly and handle can be pulled up out of the white plumbing fitting.
4. Wipe down the internal rotor assembly that attaches to the cap and handle.
5. Soak the internal rotor assembly in white vinegar.
6. The inner wall of the white plumbing fitting should also be wiped down. If the surface of the white plumbing has become too abrasive, you can take wet, fine sandpaper and smooth it out.
7. Rinse the diverter internals. Inspect O-rings for cracking or swelling and apply silicone lubricant to them. Then reassemble.



FOR THIS STYLE OF HANDLE, FOLLOW THESE STEPS:

This style of handle requires a few additional steps to get to the internal rotor assembly.

Pry up the oval emblem piece at small screw driver indent point, remove the screw that is underneath it, hold handle firmly and pull up. Then continue to follow the instructions on Step 2 listed above for the rest of disassembly and cleaning. When finished, reassemble by following the same steps in reverse.



Pry Up Oval Emblem Piece with Small Screwdriver



Remove the Oval Emblem Piece



Remove Phillips Screw



Hold Handle Firmly and Pull Up

To prevent unwarranted damage, the large diverter valves should not be turned while the pump is operating. Diverter should be adjusted while the pump is off. Cleaning your diverter valve should occur every time you drain your spa. Refer to Draining Your Spa in the Regular Maintenance Procedures section.

REGULAR MAINTENANCE PROCEDURES

▶ WATCH HOW-TO VIDEOS: masterspas.com/video-tutorials

NOTE: These maintenance procedures are the responsibility of the spa owner to perform. These procedures are not covered by the spa warranty.

CARE OF YOUR SPA COVER

Always cover your spa when not in use with an approved insulating spa cover by Master Spas. Keep the spa cover on to minimize heat loss during heating of the spa between uses (but not while it is being used). This will greatly reduce energy consumption and will cause spa water to heat more rapidly. Water loss and chemical usage will also be reduced.

- Ensure the cover is fitted tightly, as per manufacturer's instructions to maximize insulation.
- Be sure to lock down all straps on the cover after each use.
- Do not allow spa to sit uncovered in direct sunlight. The heat and UV from direct sun exposure can cause damage to exposed shell surfaces of the spa as well as damage or discoloration of the spa controls and fittings.
- See cover manual instructions for detailed instructions on proper cover care. Clean the cover at least once a month using mild soap and water. Rinse thoroughly with fresh water to remove pollutants and soap residue. If mold/mildew staining has occurred (particularly on bottom of the cover), a mixture of bleach and water used with a soft cloth may be necessary. Thoroughly rinse with fresh water after cleaning.
- Keep cover open for 15 minutes after adding chemicals to prevent excessive off gas buildup and damage.
- When the spa is being used, the cover should be placed in a clean, dry area, otherwise it can pick up dirt and bacteria. Covers should not be put on wooden tables or wooden decking because of the risk of bleaching the wood.
- The use of a cover lift accessory or other device ensures the cover will not come into contact with the ground and retains its cleanliness (particularly the surface in close proximity to the spa water surface). The cover should be stored in an appropriate location, where it cannot be damaged, or cause damage.

NOTE: If your spa is going to be left empty for prolonged periods, do not place cover directly on the spa's surface (closed and sealed). Instead, place a 1" block of high density foam between the cover and the spa. This allows for ventilation to help reduce mold and mildew from occurring while the spa is empty.

NOTE: The cover warranty is not part of the limited warranty provided with the spa. It is provided through the cover manufacturer and may not be through Master Spas. Check the tags and labeling on your cover to verify manufacturer and refer to the manufacturer's care, maintenance and warranty information. Your dealer can help provide you with these details.

NOTE: Always use the water feature controls to turn down the water flow so that the water features do not hit the cover when the cover is closed. Do not turn them all the way off.

CARE OF YOUR OZONE SYSTEM

The ozone hose and check valve connecting between the ozone generator and ozone injector should be inspected and/or replaced, if necessary, every 12 months. Depending on conditions of the air which is being brought in to the ozone generator, the ozone hose and check valve can wear more rapidly. This regular maintenance is not covered under the spa warranty. We recommend that your Master Spas Dealer or service organization be contacted to perform this type of maintenance.

REGULAR MAINTENANCE PROCEDURES

▶ WATCH HOW-TO VIDEOS: masterspas.com/video-tutorials

NOTE: These maintenance procedures are the responsibility of the spa owner to perform. These procedures are not covered by the spa warranty.

CARE OF STAINLESS STEEL

Master Spas uses stainless steel in a number of our spas. Its lasting beauty and resistance to corrosion make it an excellent material for handrails and jets faces. With the proper care it will keep its luster for many years. All stainless steel can corrode given the right circumstances so we have provided a guide to help you keep the stainless components in your spa looking nice. Stainless steel derives its ability to resist corrosion by forming a very thin transparent coating on the surface when exposed to oxygen. This coating can be damaged by abrasive materials such as steel wool, sand paper, and other cleaning materials that are abrasive. Chlorine salts, sulfides, or other rusting metals can also erode this thin coating exposing the metal to corrosion. The best defense to combat corrosion on stainless steel components in your spa is make sure that it is kept clean and free of any chemical build up.

Always:

- Clean frequently with fresh, clean water.
- Remove any rust spots as soon as they appear with vinegar or a brass, silver, or chrome cleaner.
- Use a good car cleaning wax for extra protection.
- Leave cover removed for at least 15 minutes after adding chemicals to the spa water.

Never:

- Clean with mineral acids or bleaches, steel wool or any other abrasive materials.
- Leave in contact with iron, steel any other metals.
- Close the cover immediately after adding chemicals to the water.

NOTE: Failure to take proper care of the stainless steel could result with them rusting. Rusting is not covered by the warranty.

NOTE: Do not cover the spa for 15 minutes after adding chemicals as the off gas can cause unwarranted damage. Larger dosages can require longer lengths of time to off gas. It is recommended to check spa water more frequently to allow small dosages be added as necessary versus large dosages being added less often.

SPA TROUBLESHOOTING GUIDE

NOTE: For wiring outside of U.S. and Canada, GFCI may be referred to as a RCD (residual current device). Be sure all local electrical codes are followed.

GFCI IS TRIPPING

A ground fault circuit interrupter (GFCI) is required by the National Electrical Code for your protection. The tripping of the GFCI may be caused by a component on the spa or by an electrical problem. Electrical problems include but are not limited to, a faulty GFCI breaker, spa component, power fluctuations, and/or improper wiring. If this is a new electrical service and GFCI installation, an instantly tripping GFCI may likely be caused by improper wiring of the load neutral from the GFCI to the spa. It may be necessary to contact an electrician if your Master Spas dealer recommends doing so.

NOTHING ON THE SPA OPERATES

1. Check the control panel display for any messages. If there is a message, refer to the diagnostic section on that spa model. There you will find the meaning of the message and what action is to be taken.
2. If there is no message on the control panel and the control panel is completely dark (off), try to reset the GFCI breaker.



The GFCI should be located in a weather proof box close to the spa, but no closer than 5 ft.

If the spa does not respond, or the GFCI breaker continues to trip, contact your Master Spas dealer or service organization.

SPA NOT HEATING

If the spas heater has failed, the majority of the time it will trip the GFCI breaker. If the spa is not heating and has not tripped the breaker, please follow these steps:

1. Check set water temperature at control panel to make sure it is set to desired temperature, above the current water temperature.
2. Check the "Heat Mode" that the spa is set in. The spa should be set in the Standard Mode or Ready Mode depending on the model. If placed in an Economy or Rest type mode, it changes the way the system heats and will primarily only heat during user programmed durations. See Spa Control section for further details.
3. Check the control panel for heat indicator. If heat indicator is on, wait a reasonable amount of time (at least 1 hour for 240V systems or 3-4 hours for 120V systems) to see if the water temperature is rising.
4. If heat indicator does not remain on, the system should be displaying a message indicating why it can't heat. Check the control panel for diagnostic messages. Refer to Spa Control Section titled System Related Messages. Follow steps to alleviate the message.
5. Check the control panel for light indicator. If the heat indicator is on, wait a reasonable amount of time (at least 1 hour for 240V systems or 3-4 hours for 120V systems) to see if the water temperature is rising.
6. Reset power to the spa at GFCI breaker.
7. If spa is still not heating, contact your Master Spas dealer or service organization.

SPA TROUBLESHOOTING GUIDE

WATER TEMPERATURE IS ABOVE SET TEMPERATURE (HEAT CREEP)

Because Master Spas hot tubs are well insulated and built to meet stringent energy standards, heat creep can occur. This means that the measured temperature of the water in your spa is creeping up higher than the set temperature on your control panel. Heat creep can occur as outdoor temperatures become moderate to warm or when your filter cycle durations have been adjusted above the default settings. To help manage heat creep:

1. **Vent your cover.** This means placing a folded cloth about $\frac{3}{4}$ inches (2 cm) thick under all four corners of the cover before you lock the cover down.
2. **Open your cover.** Opening the cover at night will also quickly cool the water down if desired.
NOTE: Never leave a spa cover open and unsupervised.
3. **Open all air controls.** Temporarily leave the air controls open during cooler times of the day or night. Set your filtration cycles to run during this time as well.
NOTE: If the heat creep issue has been resolved, close the air controls when not using the spa to reduce energy and chemical maintenance.
4. **Reduce the length of your filter cycles.** The default duration is generally 4 hours of filtering per day (either a duration of 2 hours that occurs twice per day or one 4-hour filter duration based on time of day).
5. **Visit your local Master Spas dealer for additional guidance.** Heat creep can happen on well-insulated hot tubs, and is related to the environment where the spa is installed and equipment runtimes such as extended filter cycle durations (especially on systems using Therapy Pump 1 low speed for filtering and heating). This is not indicative that there is a problem with the spa.

PUMP(S) DO NOT OPERATE

1. Press the “Jets” button on your control panel.

If you hear the pumps trying to operate:

- A. Check that all the slice valves are open.
- B. Pump may be air locked and needs to be primed.

Refer to Installation Instructions section. If you do not hear anything from the pump, contact your Master Spas dealer or service organization.

NOTE: If the pump(s) had been operating for 15 minutes or longer prior to ceasing operation, it may be normal and simply related to mild or warmer temperature conditions and excessive internal temperatures occurring from prolonged pump run-times. The spas are built to meet stringent energy efficiency standards and to run at full capacity during the 15 minute safety timeout periods. Operating pumps at high speed repeatedly beyond the 15 minute timeout can result in the pump motor getting too warm and shutting itself off to cool down. This would be seen by the control indicating the pump should be on still, but the pump has shut itself off internally. If this thermal cutout occurs, the pump will remain off for several minutes to cool. Once the equipment area and motor cool down, it would begin operating again.

POOR JET PERFORMANCE

1. Make sure pump is operating.
2. Check that the water level is adequate (up to minimum safe water level on sticker located near filter).
3. Make sure the jets are open and the air controls are open. Refer to Glossary of Spa Technology section.

WINTERIZING & STORING YOUR SPA

WINTERIZING YOUR SPA

Your spa is designed to be used year round in any type of climate.

However, if you decide you don't want to use your spa in the winter, you must drain it and follow the winterizing steps listed below.*

DISCLAIMER: *Master Spas does not recommend winterizing your spa. If you choose to do so, any damage that may result is not covered under the spa warranty.*

1. Drain your spa completely using the drain valve (if so equipped) or use an inexpensive submersible pump that you can buy from your local hardware store.
2. Use a shop vac to get all standing water out of your unit.
3. Remove access panels from equipment area.
4. Loosen all pump unions.
5. Remove winterizing plug from face of the pump(s) where applicable.
6. Using your shop vac in a blowing mode, insert the hose into the nozzle of each jet and blow the trapped water from the lines into the interior of the spa. A non-toxic, RV water line type antifreeze can be used and added to jets in each seat around your spa to help prevent freeze damage from occurring. Be sure to thoroughly flush the system before startup.
7. After this is completed, use the shop vac to remove any standing water in the spa and in the equipment area.
8. Clean the spa with a soft cloth and a non-abrasive spa surface cleaner.
9. Replace access panels.
10. Cover the spa to prevent water from entering it and check the spa periodically to be sure no water is entering and accumulating. Spa covers are a great insulator but will allow some precipitation to enter the spa. For this reason, it is highly advised to also cover the spa with a water tight tarp while winterized. It is beneficial to keep the spa cover slightly gapped off the acrylic shell while winterized to allow air flow in to the shell area to reduce mildew/mold buildup caused by trapped moisture.

* If you decide to winterize your spa, we recommend that you periodically check the spa throughout the winter to assure water is not entering the spa through or around the spa cover.

STORING YOUR SPA

The spa shell should never be left unprotected and uninsulated while being stored. Clear plastic wrap or similar material should never be used to cover/protect the spa.

Prolonged, direct sun heat can damage the surfaces of the spa along with any components on the spa's surface. Always keep the spa covered and protected with an insulating spa cover. Resulting damage such as cracking in the shell surface, warping or discolored components on the spa would not be warranted.

An empty spa should never be exposed to temperatures below 0°F (-18°C) after delivery as extreme cold can cause shell damage. This includes storage and draining (winterizing). If your spa will be exposed to these temperatures, keep the unit filled and running. If you do not plan to use your spa, you can set the spa to the lowest temperature setting allowed by the control system while in Standard/Ready Mode.

Failure to adhere to these guidelines may result in unwarranted damage caused to the spa.

MODEL SPECIFICATIONS

| Model | Listing Number | Spa Dimensions (in./cm) | Electrical Requirements ¹ | Seating Capacity ² | Water Capacity (gallons/m) ³ | Dry Weight (lbs./kilos) ⁴ | Full Weight (lbs./kilos) ^{3,4} | Therapy Pumps | Control System |
|-------------------------|----------------|------------------------------------|--------------------------------------|-------------------------------|---|--------------------------------------|---|---------------|----------------|
| INT BALANCE 7 | 1590 | 84" x 84" x 36" 214 x 214 x 92 | *240V, 32A 3x 240V, 16A | 6 | 390 / 1.48 | 815 / 370 | 5180 / 2350 | 2 | MS6013XE |
| INT BALANCE 8 | 1610 | 94" x 94" x 36" 239 x 239 x 92 | *240V, 32A 3x 240V, 16A | 6 | 465 / 1.76 | 900 / 408 | 5890 / 2672 | 2 | MS6013XE |
| INT BALANCE 9 | 9925 | 108" x 94" x 38" 275 x 239 x 97 | *240V, 32A 3x 240V, 16A | 8 | 615 / 2.33 | 1215 / 551 | 7825 / 3550 | 2 | MS6013XE |
| INT PRECISION 67 | 9924 | 70" x 84" x 34" 178 x 214 x 87 | *240V, 32A 3x 240V, 16A | 5-6 | 280 / 1.06 | 720 / 327 | 4170 / 1892 | 1 | MS6013XE |
| INT PRECISION 7 | 1570 | 84" x 84" x 36" 214 x 214 x 92 | *240V, 32A 3x 240V, 16A | 7 | 400 / 1.51 | 770 / 349 | 5405 / 2452 | 2 | MS6013XE |
| INT PRECISION 8 | 1580 | 94" x 94" x 36" 239 x 239 x 92 | *240V, 32A 3x 240V, 16A | 7 | 515 / 1.95 | 880 / 399 | 6475 / 2937 | 2 | MS6013XE |

¹See Electrical Requirements section for further details.

²Total bather capacity in spa. The number of bathers in spa should never exceed indicated seating capacity. Depending on spa size, water level and bather displacement; full seating capacity may not be achievable. Do not allow additional bathers to enter if bather displacement results in water levels overflowing or reaching the spa controls (air controls, diverters, spa topside control and etc.) as this will result in water leaking out of the spa shell and potentially in to the equipment area.

³Full weight based on dry weight of spa, max seating capacity of spa, assumed average weight per person of 185 pounds and estimated water weight of 8.34 pounds per gallon. Rounded up in increments of 5.

⁴Manufacturing tolerances along with other factors can result in variance in actual spa weight. If weight is a critical figure necessary for delivery, or final installation, we suggest a minimum of 15% be added to the listed weight when planning delivery or installation.

*Default Minimum Electrical Requirement as Configured from Manufacturing. See Electrical Requirements Section for Electrical Hook-Up by Control System.

Portable spa installation is simple when properly planned. It is important that you read the following information carefully and consult with your Master Spas dealer.

- 1. ACCESS:** The actual dimensions of your new spa will determine the amount of space that is needed in moving the spa from curbside to its final installation area. Be sure to consider and measure side yard dimensions, gates, doors, overall room dimensions and vertical obstructions such as ceilings, roof overhangs, balconies and overhead cables. Any other space limiting obstacles such as stairs, trees, and shrubs must also be evaluated. Consideration should also be taken to ensure there is convenient water supply for filling your spa (review national and local regulations). The desired location for spa might require use of a crane. Please be sure to contact and review these site and installation plans with your Master Spas dealer prior to delivery. It is also good to consider these access requirements for ease of removing the spa from the premises in the event it is necessary to do so.
- 2. SURFACE/PAD REQUIREMENTS:** When your new spa is filled with water and bathers, it may weigh as much as several tons. It is imperative that the base beneath the spa can support the entire weight. The spa must be on a uniformly firm, continuous, and level surface. The recommended foundation is a concrete pad with a minimum thickness of four inches with steel reinforcement bars crossed throughout the pad.

IMPORTANT

Consult experts and/or local authorities to review and comply with all local and national laws and regulations relating to childproofing, safety barriers, lighting and any other safety requirements at site. When installing your spa indoors, on a wood deck, roof or balcony, load requirements need to be evaluated before installation. It is also good to consider location and position of spa as well as surfaces and foundation to minimize noise disturbance as much as possible. You should speak with a qualified contractor or your local building department to confirm that your surface is adequate for supporting the spa and conforms to these guidelines.

All sides of the spa must be accessible for regular maintenance or in the event that service is needed. Periodical maintenance checks require entry into the equipment bay. When possible, it is wise planning for the future to leave 3 feet of access to all sides of the spa in the event your spa requires maintenance. Your spa warranty does not cover the cost of providing access for service.

GENERAL CONSIDERATIONS FOR OUTDOOR INSTALLATION

Again, proper planning will increase your total enjoyment factor with your new spa. Listed below are some additional items to consider when planning your installation.

- Local building codes (if applicable)
- Power cable
- Appropriate materials and drainage around the spa to handle water presence and runoff
- Consider local environmental conditions, such as ground water and risk of frost
- In cold climates, an insulating ground cloth can be installed between foundation and spa to minimize heat loss
- How spa will complement landscaping and vice versa
- View from inside spa and view of spa from inside of home
- Exposure to sunlight and shading from trees
- Privacy
- Getting to spa from the house and back
- Proximity to dressing rooms and bathrooms
- Storage for spa chemicals

SITE PREPARATION / GENERAL GUIDELINES

GENERAL CONSIDERATIONS FOR INDOOR INSTALLATION

Installing your spa indoors creates an entirely different set of considerations.

- Work with your Master Spas dealer and contractor to insure all local building, electrical and plumbing codes are met
- Plan for proper flooring and floor drains around your spa to drain off excess water runoff that will occur during normal use and for draining and cleaning your spa
- Proper room ventilation and dehumidification
- Finished materials in your spa room should also be capable of withstanding increased humidity and moisture

GUIDELINES FOR PARTIALLY OR FULLY RECESSED INSTALLATION

Spas manufactured by Master Spas are designed to be installed in a variety of settings. One of which is installing below grade. Should a spa be installed below the level of the site drainage system (below grade), a system for preventing water collecting and pooling must be designed based on the requirements of the local authority having jurisdiction. The drainage system must be designed based on things such as rainfall, water runoff, splashing, draining the spa, etc., that could potentially feed the below grade area with water. When located in designated floodways, additional attention to maximum water load entering the area below grade must be addressed to prevent water from accumulating below grade at all times. It is generally recommended that the spa be installed above grade because the spa is not designed to be submerged in water. When a proper drainage system is designed and proper ventilation is planned based on the characteristics of the site, installing the spa below grade is an accepted method of installation.

- The unit is self-supporting when placed on a surface designed to support the full load of the spa (see Surface/Pad Requirements). Do not backfill with sand, gravel, or earth. Doing so will void the warranty.
- Plan for complete drainage so that water accumulation drains away from the spa perimeter and standing water never reaches the electrical equipment.
- Plan for appropriate ventilation to remove moisture accumulation and to prevent equipment from overheating.
- Provide a minimum of 3 feet service area around the perimeter of the unit. Site access issues are not covered by the product warranty.
- The unit is not designed to be submerged in water. Water entering the equipment area creates many hazards and resulting damage will not be covered by the product warranty.
- Make sure that the surroundings do not create any additional hazards.
- Surfaces placed around the unit should also be evaluated for walking/slipping hazards from standing water. Proper drainage is vital to the installation of a below grade installation.
- Check all building, electrical, and plumbing codes with the authority having jurisdiction to ensure that your installation is in compliance with all local codes.
- Additional consideration needs to be made when installing unit in designed floodways.
- Verify that site specific drainage systems such as down spouts are not going to feed the area below grade.
- Below grade drainage system needs to be evaluated based on area specific rainfall. One size does not fit all so an analysis by a qualified, local engineer to ensure proper drainage of all sources of water is a must when installing below grade.

SITE PREPARATION / GENERAL GUIDELINES

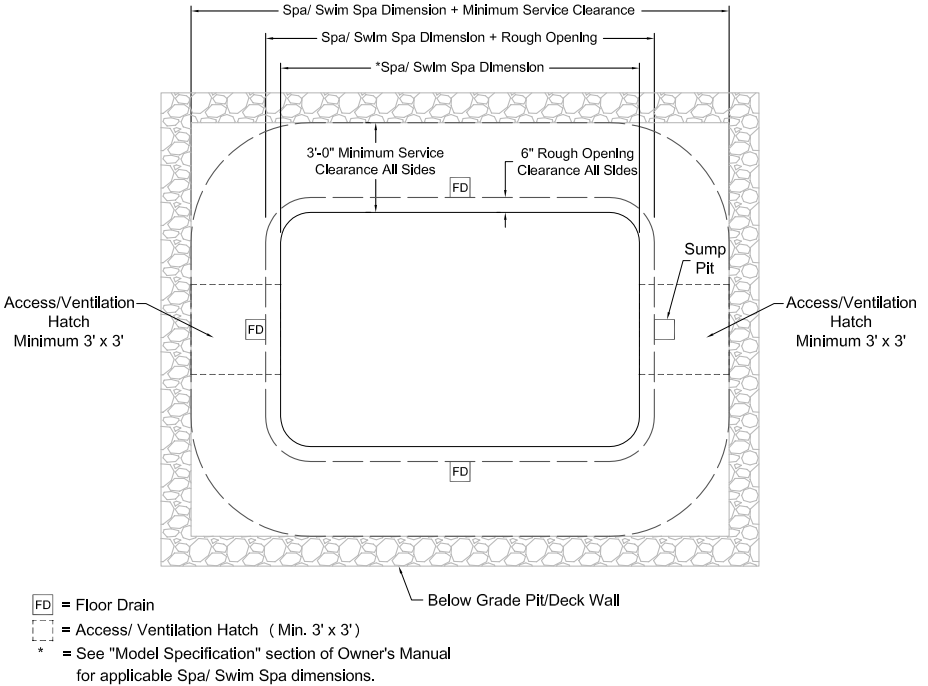

ELECTRICAL REQUIREMENTS

ALL MODELS

NOTE: Electrical requirements by model is shown in Model Specifications. Only electrical configurations pertaining to the models referenced in this manual are shown.

ELECTRICAL REQUIREMENTS

HAVE YOUR ELECTRICIAN READ THE FOLLOWING INFORMATION BEFORE INSTALLATION BEGINS

Electrical connections made improperly, or the use of wire gauge sizes for incurring power which are too small, may continually blow fuses in the electrical equipment box, may damage the internal electrical controls and components, may be unsafe and in any case will void your warranty.

It is the responsibility of the spa owner to ensure that electrical connections are made by a qualified electrician in accordance with codes regulated by the authority having jurisdiction at the time of installation.

These connections must be made in accordance with the wiring diagrams found inside the control box and in this manual. This equipment has been designed to operate on and requires 230V, 50Hz service. Make sure that power is not applied while performing any electrical installation. A bonding lug for bonding copper wire has been provided on the electrical equipment pack to allow connection to local ground points. The ground wire must be at least 8 AWG (8.36mm² copper wire unless local or state codes require a heavier gauge wire) and must be connected securely to a grounded metal structure such as a metallic cold water pipe. Be sure to have a licensed electrician examine and ensure proper grounding is provided. See chart on next page for wire size conversion. All Master Spas equipment packs are wired for 230 VAC only. The only electrical supply for your spa must include a switch or circuit breaker to open all non-grounded supply conductors to comply with BS7671 (or other local jurisdiction code or law). The disconnect must be readily accessible to the spa occupants, but installed at least five feet from the spa. Residual Current Device (RCD) must be used to comply with this manual, BS 7671, or any local electrical code or law requirements. A residual current is a current leak from any one of the supply conductors to ground. An RCD is designed to automatically shut off power to a piece of equipment when a ground fault is detected.

Route the cable into the equipment area for final hook-up to terminals inside the control pack or junction box. The spa must be hooked up to a "dedicated" breaker(s) and RCD. The term "dedicated" means the electrical circuit for the spa is not being used for any other electrical items (patio lights, appliances, garage circuits, etc.). If the spa is connected to a non-dedicated circuit, overloading will result in "nuisance tripping" which requires resetting of the breaker switch at the house electrical panel.

202012

ELECTRICAL REQUIREMENTS

230 VOLT 50 HZ – RESIDUAL CURRENT DEVICES (RCDs)

A residual current device (RCD) is the generic term for a device that monitors the current in the line conductor and the neutral conductor in an earthed system.

In a circuit that's operating properly, the vector sum of the live and neutral current values added together will be zero. Current flowing to earth, due to a line earth fault, will return via the earth conductor, and regardless of load conditions, will be registered as a fault. This current flow will give rise to a residual current that will be detected by the device. If the residual current exceeds the rated sensitivity of the RCD, it will automatically activate a tripping of the faulty circuit.



Two Pole RCD



Four Pole RCD

Typical specifications are as follows:

- Residual Current Devices (RCDs) range
- Sensitivity – from 10 to 30mA
- Voltage – 2 poles: 230V; 3/4 poles: 230/400V
- Connection capacity
 - 25A: 6/10 mm² (flexible/rigid cable)
 - 40,60A: 16/25 mm²
 - 80,100A: 35/50 mm²

| Total Ampere Rating of Power System | Minimum Wire Size Use Copper ONLY with 90°C Insulation | Ampere Rating of RCD Circuit-Breaker |
|-------------------------------------|---|--------------------------------------|
| 0 A to 16 A | #12 AWG / 3.31 mm ² | 20 |
| 16 A to 20 A | #10 AWG / 5.26 mm ² | 25 |
| 20 A to 24 A | #10 AWG / 5.26 mm ² | 30 |
| 24 A to 28 A | #8 AWG / 8.36 mm ² | 35 |
| 28 A to 32 A | #8 AWG / 8.36 mm ² | 40 |

CAUTION – Actual wiring of RCD will vary by manufacturer of RCD. Improper wiring of RCD may result in permanent damage to spa control pack. Repair/replacement of spa system box is not covered under warranty when damage results from improper wiring. Actual wire attachment points on the Spa Control Pack may vary. Always refer to the wiring diagram inside the Spa Control Pack for proper power connection.

ELECTRICAL REQUIREMENTS

MS6013XE HOOK-UP

AS MANUFACTURED – SINGLE SERVICE (Figure 1)

Single Service, TN and TT Electrical Systems (1x13 Amp, 1x16 Amp or 1x32 Amp)* 3 Wires (1 Line + 1 Neutral + 1 Protective Earth). Protective Earth wire (Green/Yellow) must be connected to system ground terminal as marked.

Heat Disable dip switches (Switch Bank S1, A2-A4) must be evaluated to prevent the spa maximum ampacity from exceeding the service maximum ampacity. When wiring spa to electrical requirements as configured from factory, dip switch settings should not be changed from factory settings.*

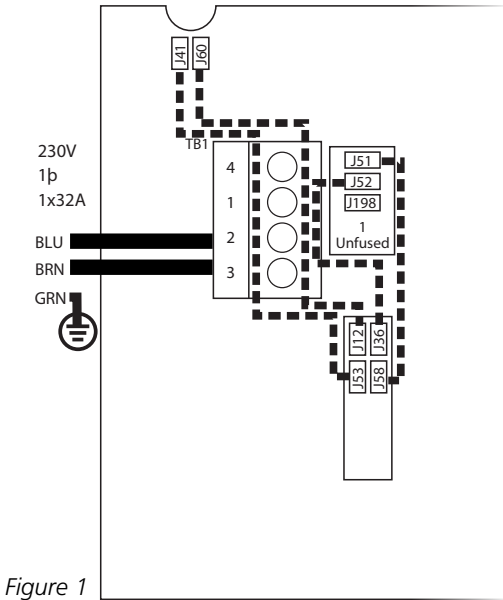

*Wiring must be sized to spa specification. Spa rated maximum ampacity cannot exceed the service maximum ampacity. This does not represent an option to the Installer. See Model Specifications page for electrical requirements by spa model.

CAUTION – RCD will vary by manufacturer of RCD. Improper wiring of RCD may result in permanent damage to spa control pack. Repair/replacement of spa system box is not covered under warranty when damage results from improper wiring. Actual wire attachment points on the Spa Control Pack may vary. Always refer to the wiring diagram inside the Spa Control Pack for proper power connection.

ELECTRICAL REQUIREMENTS

MS6013XE HOOK-UP

OPTIONAL HOOKUP – 3 SERVICE (Figure 2)

3-Phase Service, TN and TT Electrical Systems 5 Wires (3 Lines + 1 Neutral + 1 Protective Earth)*. Protective Earth wire (Green/Yellow) must be connected to system ground terminal as marked.

1. Remove all jumper wires as indicated by dotted lines in Figure 1 (previous page).
2. Only reinstall jumper wires as indicated by dotted lines in Figure 2.

IMPORTANT – EACH SERVICE MUST INCLUDE A NEUTRAL WIRE, WITH A LINE TO NEUTRAL VOLTAGE OF 230VAC.

Heat Disable dip switches (Switch Bank S1, A2-A4) must be evaluated to prevent the spa maximum ampacity from exceeding the service maximum ampacity per line (L1, L2 & L3).

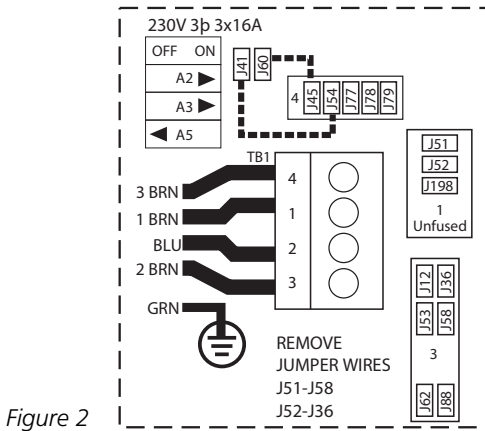

Figure 2

*Wiring must be sized to spa specification. Spa rated maximum ampacity cannot exceed the service maximum ampacity. This does not represent an option to the Installer. See Model Specifications page for electrical requirements by spa model.

CAUTION – RCD will vary by manufacturer of RCD. Improper wiring of RCD may result in permanent damage to spa control pack. Repair/replacement of spa system box is not covered under warranty when damage results from improper wiring. Actual wire attachment points on the Spa Control Pack may vary. Always refer to the wiring diagram inside the Spa Control Pack for proper power connection.

▶ WATCH HOW-TO VIDEOS: masterspas.com/video-tutorials

SETUP STEPS

1. Put spa in final position that allows for access to equipment and spa components. Master Spas recommends that at least 3 feet of space be provided around all sides of the spa for access. This provides adequate space for regular maintenance and service.
2. Remove front skirt panel (this is the side where the topside control panel is located) so electrical can be hooked up to the spa control system. This panel is removed by unscrewing the screws securing the skirt corners and the front skirt panel.
3. With the front skirt panels removed allowing access to the equipment, be sure all pump and heater unions are secure. Each pump has 2 unions and the heater has 2 unions. A newly delivered spa may have loose unions caused in transporting the spa. Check that all slice valves are open, in the up position. The slice valves may become closed during transportation of the spa.

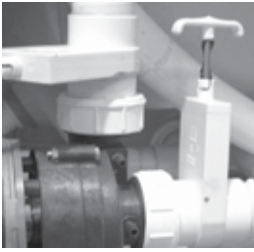

*Slice Valve
and Pump Union*

4. Fill spa to minimum water level label indication located on the spa shell near the filter area or at least 1" above the filters or filter housing opening. We recommend filling the spa through the filter area to help reduce air locks from occurring in the filter and heating pump. When filling or topping off water, do not exceed the maximum fill level indication on the water level label.
NOTE: In below freezing temperatures, caution should be taken when planning to install a spa and fill it with water. As it takes time for the water to fill the spa and reach the proper minimum water level, the water entering the various plumbing lines and equipment may begin to freeze up when done in winter weather conditions. This could result in pumps being seized until thawed or other potentially worse freeze damage occurring to the equipment and plumbing lines.
5. Turn the power on to the spa. Once the system and control panel loads to operational state, activate each jet pump to ensure they are not air locked before the system continues normal heating and filtering operations. See the spa controls section of this manual for additional instructions on control startup.
6. Be sure the adjustable jets in your spa are open by turning the face of the jet. Most of the jets in your spa are adjustable and removable by turning the face of the jet.

INITIAL SPA SETUP

7. It may be necessary to bleed air from the pump(s) in your spa if, after start up, your spa pumps are turning on and off but you do not have water flow from the jets in your spa. Due to the nature of water flow and hydro-therapy pumps, please be advised that air locking of pumps may occur. Master Spas has taken measures to reduce the possibility of this, but it still may occur, especially after refilling a spa. This is not a service covered under warranty and service charges may apply.
- To relieve an airlock situation, loosen the pump union on the discharge of the pump. This pump union is indicated by an arrow in the picture below. Water should leak out of the union once the air has been removed. Tighten the union and test the pump for proper operation. Repeat this process if needed.

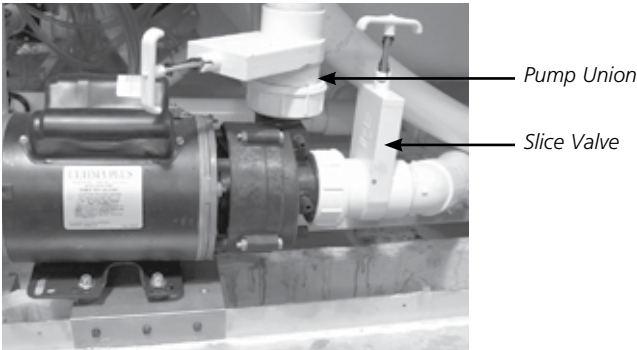

Airlock

8. Adjust water chemistry according to the instructions provided in the Water Maintenance section.
9. *Your spa water will heat approximately 3 to 4 degrees Fahrenheit per hour (1 to 2 degrees Celsius) with the cover placed on the spa. This varies depending on the size of the spa and ambient temperatures.
10. Step into the soothing waters of your Master Spa!
Relax and enjoy.

*240V systems only. 120V spa models increase at approximately 1°F per hour (can vary depending on model and temperature conditions).



WATCH HOW-TO VIDEOS:
masterspas.com/video-tutorials

SPA CONTROLS - MP30/TP600

EN 17125

MAIN MENUS



NAVIGATION

Navigating the entire menu structure is done with 2 or 3 buttons on the control panel.

Some panels have separate **WARM** (Up) and **COOL** (Down) buttons, while others have a single **TEMPERATURE** button. In the navigation diagrams Temperature buttons are indicated by a single button icon.

The **LIGHT** button turns the lights (if equipped) inside your spa on or off. If your spa is equipped with LED Light System, turn the lights on and off repeatedly within a couple of seconds to rotate through available color schemes.



Typical use of the Temperature button(s) allows for changing the Set Temperature while the numbers are flashing in the LCD. Pressing the **LIGHT** button while the numbers are flashing will enter the menus.

The menus can be exited with certain button presses. Or, simply waiting for several seconds will return the panel operation to normal.

POWER-UP SCREENS

Each time the System powers up, a series of numbers is displayed. After the startup sequence of numbers, the system will enter Priming Mode.

KEY

-  Indicates Flashing or Changing Segment
-  Indicates Alternating or Progressive Message - every 1/2 second
- A temperature button, used for "Action"

Waiting time that keeps the last change to a menu item.

***** Waiting time (depends on menu item) that reverts to original setting and ignores any change to that menu item.

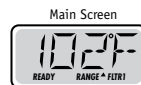
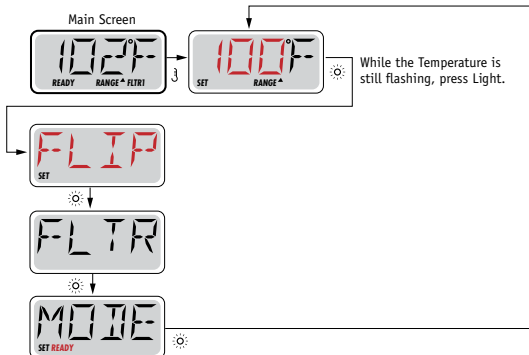

Waiting Several Seconds in the Main Menu will allow the display to revert to the Main Screen. Most changes are not saved unless Light  is pressed. Refer to Key above.

SPA CONTROLS - MP 30/TP600

INITIAL START-UP

PREPARATION AND FILLING

Fill the spa to its correct operating level. Be sure to open all valves and jets in the plumbing system before filling to allow as much air as possible to escape from the plumbing and the control system during the filling process. It is always best practice to fill the spa at the filter area.

After turning the power on at the main power panel, the top-side control panel display will go through specific sequences. These sequences are normal and display a variety of information regarding the configuration of the hot tub control.

PRIMING MODE

This mode will last for 4-5 minutes or you can manually exit the Priming Mode after the pump(s) have primed, by pressing a **WARM** or **COOL** button (or **TEMP**).



Regardless of whether the priming mode ends automatically or you manually exit the priming mode, the system will automatically return to normal heating and filtering at the end of the Priming Mode. During the Priming Mode, the normal system's programming and heating is disabled to allow the priming process to be completed by the user without the possibility of turning on the heater under low-flow or no-flow conditions. Nothing comes on automatically, but the pump(s) can be energized by pushing the **JETS** button. If the spa has a 24 hour Circulation Pump, it can be activated by pressing the **LIGHT** button during Priming Mode.

PRIMING THE PUMPS

As soon as the Priming Mode screen appears on the panel, select the "Jets 1" button once to start Pump 1 in low-speed (if applicable) and then again to switch to high-speed. If the pump is operating but there is no water flow after 10 seconds of running, shut the pump off for 5-10 seconds and then back on for 5-10 seconds. Repeat until water begins flowing, this means the pump is primed. Also select the other pumps to turn them on and perform this priming process if necessary. If the pumps have not primed after 4-5 minutes, and water is not flowing from the jets in the spa, do not allow the pumps to continue to run. Turn the spa off, then back on and repeat the process. **NOTE:** Turning the power off and back on again will initiate a new pump priming session. Do not do this more than 5 times. If the pump(s) will not prime, shut off the power to the spa and see instructions for relieving an air lock in the Initial Spa Setup section.

IMPORTANT: A pump should not be allowed to run continuously without priming for more than 2 minutes. Under NO circumstances should a pump be allowed to run without priming beyond the end of the 4-5 minute priming mode. Doing so may cause damage to the pump and cause the system to energize the heater and go into an overheat condition.

EXITING PRIMING MODE

You can manually exit Priming Mode by pressing a Temperature button, **WARM** (Up) or **COOL** (Down). Note that if you do not manually exit the priming mode as described above, the Priming Mode will be automatically terminated after 4-5 minutes. Be sure that the pump(s) have been primed by this time. Once the system has exited Priming Mode, the top-side control panel will momentarily display the set temperature but the display will not show the temperature yet, as shown below. This is because the system requires approximately 1 minute of water flowing through the heater to determine the water temperature and display it.



SPA CONTROLS - MP 30/TP600

SPA BEHAVIOR

PUMPS

Press **JETS** or **AUX** button once to turn the pump on or off, and to shift between low and high speeds if equipped. If left running, the pump will turn off after a 15 minute time-out period.

NON-CIRCULATION SYSTEMS

To monitor current water temperature, the system will automatically activate Pump 1 at the low-speed setting as needed. If the spa is in Ready Mode, Pump 1 low may activate for at least 1 minute every 30 minutes to monitor the spa water temperature (known as polling) and begin to heat if water temperature has dropped below the set temperature. If the water temperature remains consistent over long periods, and does not decrease, the M8 technology in your spa will actively adapt these polling intervals to be less frequent. If the water temperature conditions are very stable, M8 will gradually increase time between the intervals, up to 2 hours. If the water temperature starts dropping significantly, the system will check the water temperature (poll) more frequently, reverting the interval back to every 30 minutes. It will also reset the intervals back to 30 minutes whenever the user interacts with the system (such as activating equipment, changing heating modes and modifying the set temperature).

Pump 1 runs automatically, at the low-speed setting, when any other pump is turned on (if equipped) so that the system can monitor the spa water temperature.

When the low-speed of Pump 1 turns on automatically for either temperature polling, heating or filter cycles, it cannot be turned off at the control panel. However, the high speed setting on the pump can be turned on.

CIRCULATION PUMP

The 24 hour circulation pump operates continuously with the exception of turning off for 30 minutes at a time when the water temperature reaches 3°F (1.5°C) above the set temperature (most likely to happen in warm climates).

FILTRATION AND OZONE

On non-circulation systems, Pump 1 low and the ozone generator will run during filtration. On 24 hour circulation systems, the ozone will run with the 24 hour circulation pump.

The system has factory default programming of 4 hours of dedicated filtration time per day. Depending on the system, it will either do 2, 2 hour filter cycles that are 12 hours apart from each start point (seen by a FLTR "12" on bottom of screen) or 1, 4 hour cycle per day.

At the start of each filter cycle, Pump 2 (if there is one) will run briefly to purge its plumbing to maintain good water quality.

FREEZE PROTECTION

If the temperature sensors within the heater detect a low enough temperature, then the pump(s) automatically activate to provide freeze protection. The pump(s) will run either continuously or periodically depending on conditions. If the temperature sensors detect a drop to below 44°F (6.7°C) within the heater, the pump will automatically activate to provide freeze protection. The equipment stays on until 4 minutes after the sensors detect that the spa temperature has risen to 45°F (7.2°C) or higher. During freeze protection the heater will not be activated.

SPA CONTROLS - MP 30/TP600

TEMPERATURE & TEMP RANGE

ADJUSTING THE SET TEMPERATURE

When using a panel with Up and Down buttons (Temperature buttons), pressing **UP** or **DOWN** will cause the temperature to flash. Pressing a temperature button again will adjust the set temperature in the direction indicated on the button. When the LCD stops flashing, the spa will heat to the new set temperature when required.

If the panel has a single **TEMP** button, pressing the button will cause the temperature to flash. Pressing the button again will cause the temperature to change in one direction (e.g. UP). After allowing the display to stop flashing, pressing the **TEMP** button will cause the temperature to flash and then the next press will change the temperature in the opposite direction (e.g. DOWN).

The temperature can be set between 80°F (26°C) and 104°F (40°C). Consider that the comfortable temperature range during use may be lower than the maximum safe temperature. Check the set water temperature and consider lowering it for the times when the spa will typically not be in use.

PRESS-AND-HOLD

If a temperature button is pressed, **WARM** (Up), **COOL** (Down) or single **TEMP**; and held when the temperature is flashing, the temperature will continue to change until the button is released. On one Temperature button spa models, if the limit of the Temperature Range is reached when the button is being held, the progression will reverse direction.

SPA CONTROLS - MP 30/TP600

MODE - READY & REST

In order for the spa to heat, a pump needs to circulate water through the heater. The pump that performs this function is known as the "heater pump." The heater pump can be either a 2-Speed Pump 1 or a 24 hour circulation pump.

If the heater pump is a 2-Speed Pump 1, **Ready Mode** will circulate water periodically, using Pump 1 Low, in order to maintain a constant water temperature, heat as needed, and refresh the temperature display. This is known as "polling."

Rest Mode If the spa is not going to be used for prolonged period of time, consider using this mode, which will only allow heating during programmed filter cycles. Since polling does not occur, the temperature display may not show a current temperature until the heater pump has been running for a minute or two. Using Rest Mode is not recommended in below freezing temperatures.

24 Hour Circulation Mode The 24 hour circulation pump operates continuously with the exception of turning off for 30 minutes at a time when the water temperature reaches 3°F (1.5°C) above the set temperature (most likely to happen in warm climates or if the set temperature is decreased below the current water temp to meet this condition). If the spa is configured for 24 hour circulation, the heater pump runs continuously. Since the heater pump is always running, the spa will maintain set temperature and heat as needed in Ready Mode, without polling.

In Rest Mode, the spa will only heat to set temperature during programmed filter times, even though the water is being filtered constantly when in Circulation Mode.

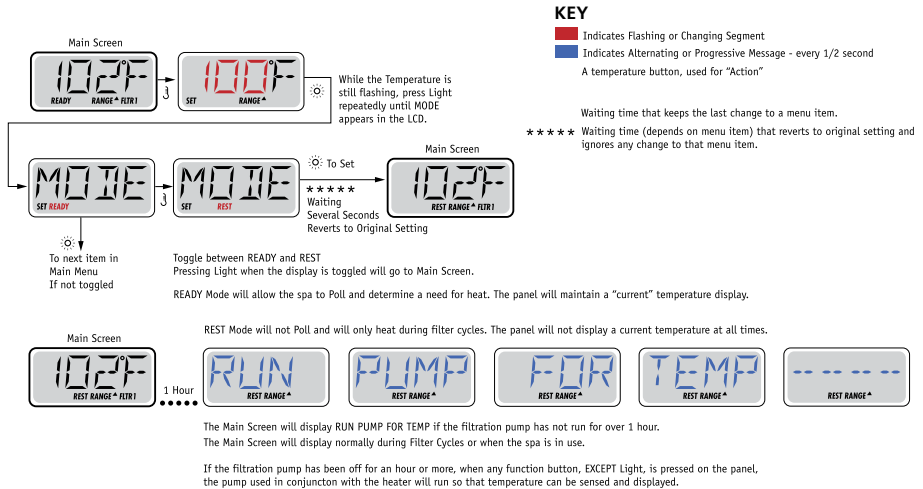

READY-IN-REST MODE

READY/REST appears on the display if the spa is in Rest Mode and Jet 1 or Aux pump (if equipped) is pressed. Upon user activation of the pumps, the system assumes that the spa is being used and will heat to set temperature. While Pump 1 High can be turned on and off, Pump 1 Low will run until set temperature is reached, or 1 hour has passed. After 1 hour, the System will revert to Rest Mode. This mode can also be reset by entering the Mode Menu and changing the Mode.

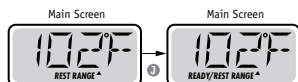

SPA CONTROLS - MP 30/TP600

FLIP (INVERT DISPLAY)

KEY

- Indicates Flashing or Changing Segment
- Indicates Alternating or Progressive Message - every 1/2 second
- A temperature button, used for "Action"

Waiting time that keeps the last change to a menu item.

***** Waiting time (depends on menu item) that reverts to original setting and ignores any change to that menu item.

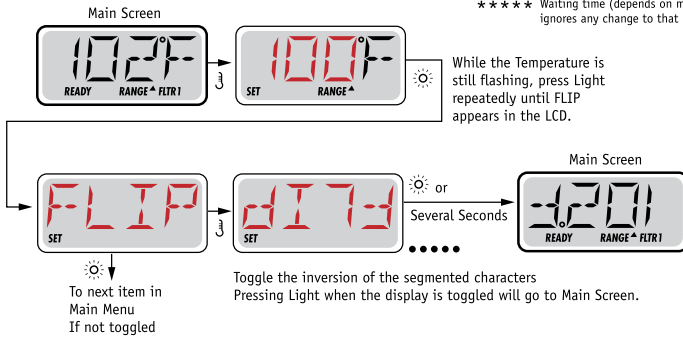

NOTE: Some panels may have a dedicated **FLIP** button, which allows the user to flip the display with a single button-press.

ADJUSTING FILTRATION

MAIN FILTRATION

Filter cycles are set using a duration. The duration setting can be adjusted in 1 hour increments. Filter Cycle 1 and Filter Cycle 2 (if enabled) are set to the same duration.

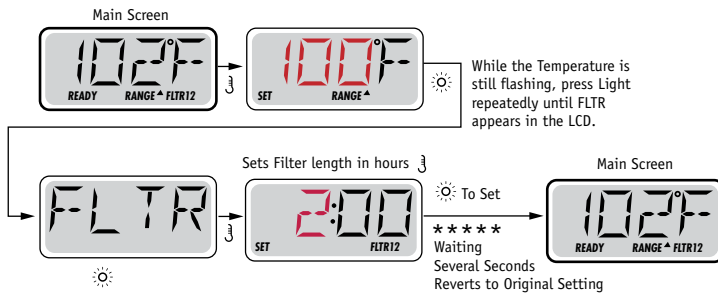

If Filter Cycle 2 is enabled, filtration indication of "12" will appear in the LCD. If filter cycle 2 is disabled, only filtration "1" will appear. This cannot be changed through the simple menu on this control panel and is based on the control system present (as to whether the system will do 1 cycle per day or 2 per day).

PURGE CYCLES

In order to maintain sanitary conditions, as well as protect against freezing, all pumps will purge water from their respective plumbing by running briefly at the beginning of each filter cycle. It is best that all jets be left in their open position and water diverters in their centered positions when done using the spa so all jets get water flow during purge cycles.

SPA CONTROLS - MP 30/TP600

GENERAL MESSAGES



PRIMING MODE

Each time the spa is powered up, it will enter Priming Mode. The purpose of Priming Mode is to allow the user to run each pump and manually verify that the pumps are primed (air is purged) and water is flowing. This typically requires observing the output of each pump separately and is generally not possible in normal operation. The Priming Mode lasts 4 minutes, but you can exit it earlier by pressing any Temp button. The heater is not allowed to run during Priming Mode.

NOTE: If your spa has a 24 hour Circulation Pump, it will turn on with Jets 1 in Priming Mode. The 24 hour Circulation Pump will run by itself when Priming Mode is exited.



WATER TEMPERATURE IS UNKNOWN

After the pump has been running for 1 minute, the temperature will be displayed.



TOO COLD – FREEZE PROTECTION

A potential freeze condition has been detected, and all pumps are activated. All pumps are on for at least 4 minutes after the potential freeze condition has ended.

In some cases, pumps may turn on and off and the heater may operate during Freeze Protection.

This is an operational message, not an error indication.



WATER IS TOO HOT

One of the water temp sensors has detected spa water temp 110°F (43.3°C) and spa functions are disabled. System will auto reset when the spa water temp is below 108°F (42.2°C). Check for extended pump operation or high ambient temp.

SPA CONTROLS - MP 30/TP600

HEATER RELATED MESSAGES

HTR FLOW LOSS -----

HEATER FLOW IS REDUCED

There may not be enough water flow through the heater to carry the heat away from the heating element. Heater start up will begin again after about 1 min. See "Flow Related Checks" below.

HTR FLOW FAIL -----

HEATER FLOW IS REDUCED*

Several Heater Flow Losses have occurred within 24 hours indicating confirmed low flow or complete flow loss. There is not enough water flow being constantly maintained through the heater to carry the heat away from the heating element and the heater has been disabled. See "Flow Related Checks" below. After the problem has been resolved, press any button to reset and restart heater.

HTR MAY BE DRY ----- WAIT -----

HEATER MAY BE DRY*

Possible dry heater, not enough water in or flowing to the heater to start it. The spa is shut down for 15 minutes but will retry (up to 3 times). Press any button to reset the heater start-up. See "Flow Related Checks" below.

HTR DRY -----

HEATER IS DRY*

Consecutive Heater May Be Dry errors have occurred and there is a verified problem. There is a flow restriction, no flow or air lock in system preventing proper water flow for heater operation. The spa is shut down. After the problem has been resolved, press any button to reset and restart heater. See "Flow Related Checks" below.

HTR TOO HOT -----

HEATER IS TOO HOT*

One of the water temp sensors has detected 118°F (47.8°C) in the heater and the spa is shut down. Press any button to reset when water is below 108°F (42.2°C). See "Flow Related Checks" below.

PRES BTN TO RESET -----

A RESET MESSAGE MAY APPEAR WITH OTHER MESSAGES

Some errors may require power to be removed and restored.

FLOW-RELATED CHECKS

Check filters for possible blockage. Try cleaning or replacing filters (especially if the spa is equipped with 24 hour circulation pump). Check for low water level, suction flow restrictions (i.e. any leaves or debris pulled against suction fittings in bottom of spa shell), closed valves, too many closed jets and pump prime/air locked pump (see Initial Spa Setup section for instructions on relieving pump air lock). On some systems even when the spa is shut down by an error condition, some equipment may occasionally turn on to continue monitoring the temperature or if freeze protection is needed.

* This message can be reset from the topside control panel by pressing any button.

DO NOT DIVE.

SPA CONTROLS - MP 30/TP600

SENSOR RELATED MESSAGES



SENSOR BALANCE IS POOR

The temperature sensors MAY be out of sync by 2°F or 3°F. Contact your Master Spas dealer or service organization.



SENSOR BALANCE IS POOR*

The temperature sensors failed to balance and have remained out of sync for more than 1 hour. Contact your Master Spas dealer or service organization.



SENSOR FAILURE – SENSOR A, SENSOR B

A temperature sensor or sensor circuit has failed. Contact your Master Spas dealer or service organization.

MISCELLANEOUS MESSAGES



NO COMMUNICATIONS

The control panel is not receiving communication from the System. Contact your Master Spas dealer or service organization.



°F OR °C IS REPLACED BY °T

The Control System is in Test Mode. Contact your Master Spas dealer or service organization.

* This message can be reset from the topside control panel by pressing any button.

SPA CONTROLS - MP 30/TP600

SYSTEM RELATED MESSAGES



MEMORY FAILURE – CHECKSUM ERROR*

At power up, the system has failed the Program Checksum Test. This indicates a problem with the firmware (operation program). Contact your Master Spas dealer or service organization.



MEMORY WARNING – PERSISTENT MEMORY RESET*

Appears after any system setup change. Contact your Master Spas dealer or service organization if this message appears on more than one power up, or if it appears after the system has been running normally for a period of time.

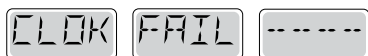

MEMORY FAILURE – CLOCK ERROR*

Contact your Master Spas dealer or service organization.



CONFIGURATION ERROR – SPA WILL NOT START UP

Contact your Master Spas dealer or service organization.



A PUMP APPEARS TO BE STUCK ON

Water may be overheated. POWER DOWN THE SPA. DO NOT ENTER THE WATER. Contact your Master Spas dealer or service organization.



A PUMP APPEARS TO HAVE BEEN STUCK ON WHEN SPA WAS LAST POWERED

POWER DOWN THE SPA. DO NOT ENTER THE WATER. Contact your Master Spas dealer or service organization.

* This message can be reset from the topside control panel by pressing any button.

SPA CONTROLS - PUMP DIAGRAMS

INT BALANCE 7

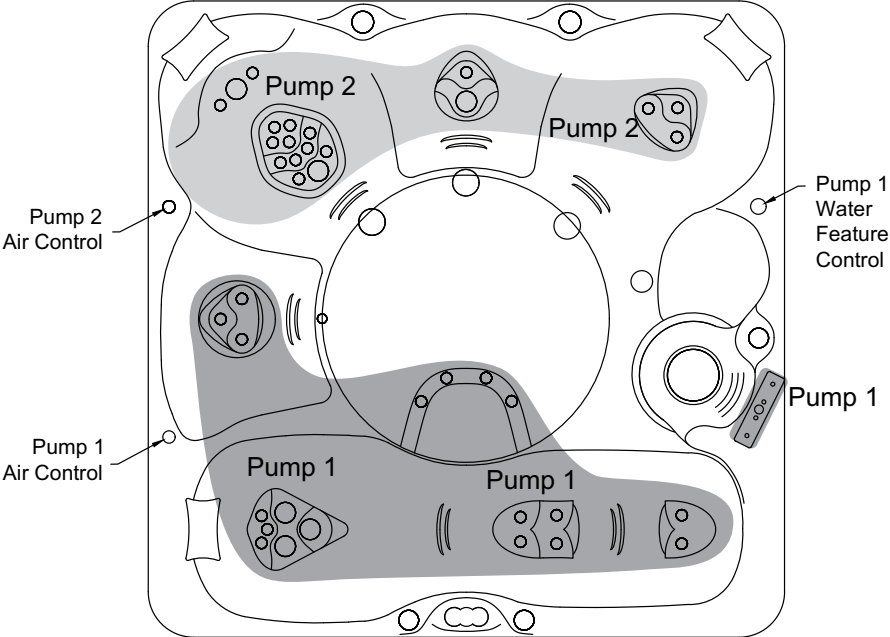

REV. 112019

SPA CONTROLS - PUMP DIAGRAMS

INT BALANCE 8

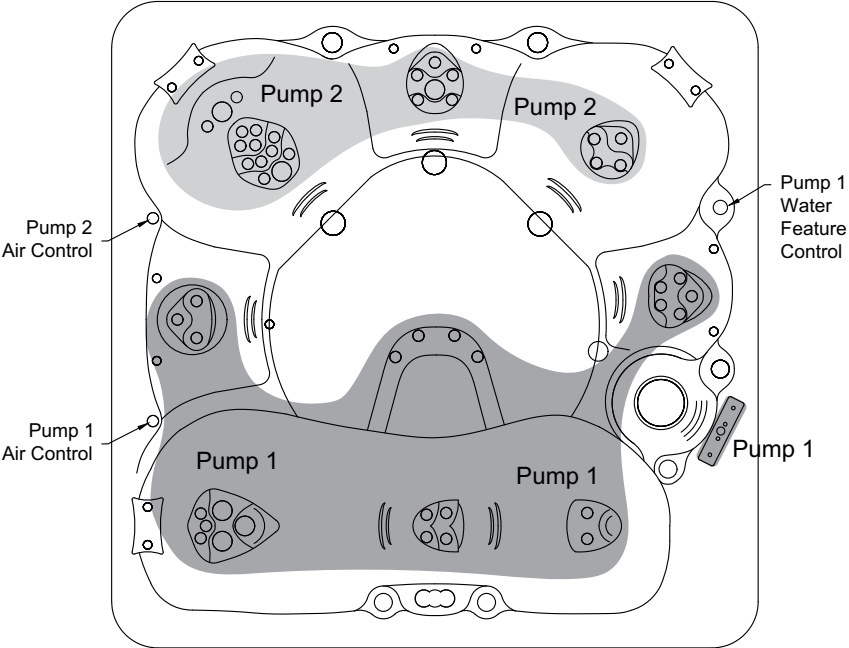

REV. 112019

SPA CONTROLS - PUMP DIAGRAMS

INT BALANCE 9

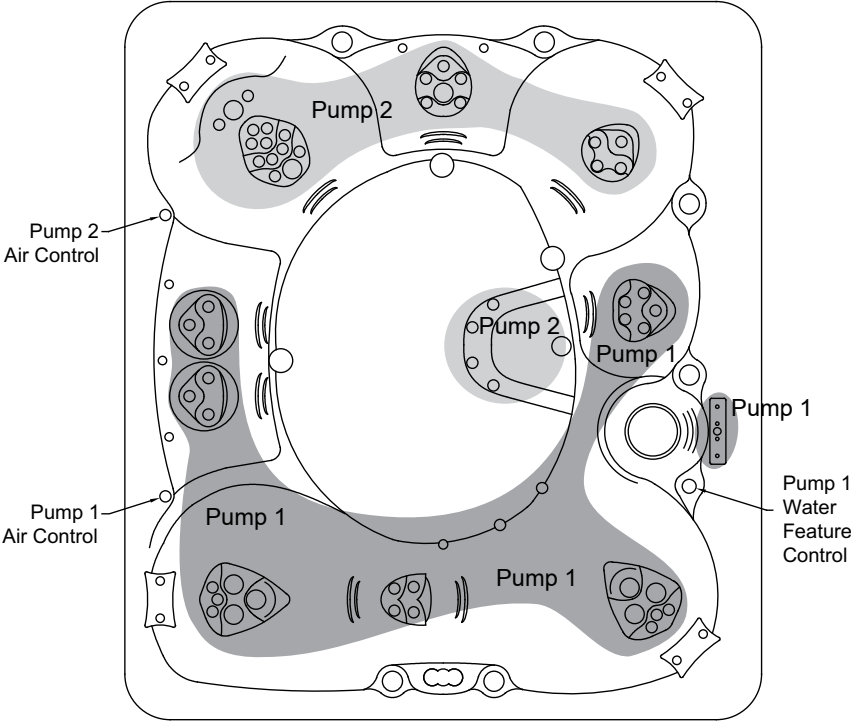

REV. 112019

SPA CONTROLS - PUMP DIAGRAMS

INT PRECISION 67

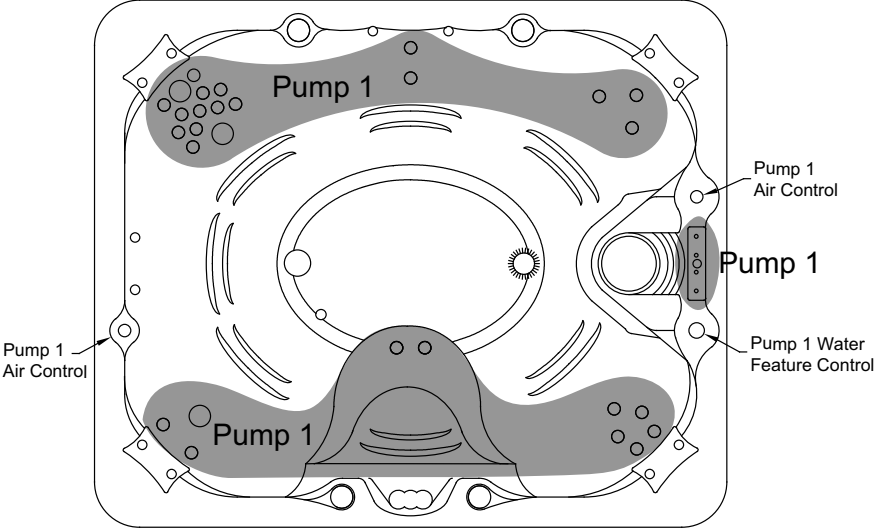

REV. 11/2019

SPA CONTROLS - PUMP DIAGRAMS

INT PRECISION 7

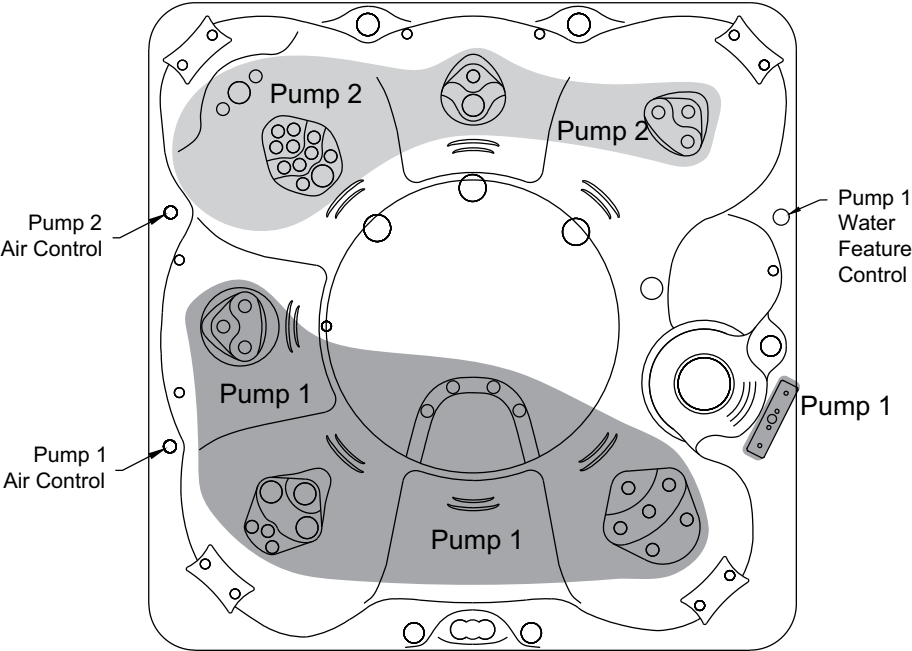

REV. 112019

SPA CONTROLS - PUMP DIAGRAMS

INT PRECISION 8

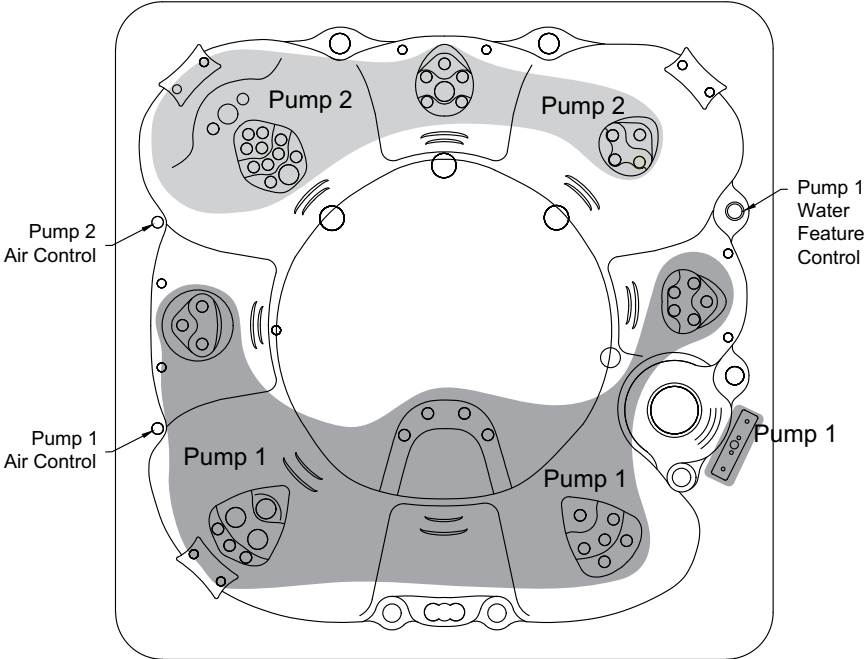

REV.112019

FUSION AIR SOUND SYSTEM (IF EQUIPPED)

REMOTE CONTROL POWER & SYNCING

WARNING – Never remain in your spa longer than 15 minutes per session when the water temperature is above 98°F. If you wish to spend more time in your spa, whether enjoying music, or just lounging, be sure to keep the spa water at or below body temperature (98.6°F).

WARNING – Prevent Electrocutation. Do not connect any auxiliary/external components to the system (i.e. cables, additional speakers, headphones, additional Audio/Video components, etc.).

HANDHELD REMOTE CONTROL CHARGING

The remote has a built-in Polymer Lithium rechargeable battery and comes with a charging cable. Connect one end of the charging cable to the charging connection on remote control and connect the USB end of the charging cable to any USB charger (5V DC) for charging. Be sure charging connection is dry or allowed to dry before connecting to charge.



Make sure the remote has been charged before used. Do not leave remote under spa cover when not in use. Always store remote in dry location when not it in use.

HANDHELD REMOTE CONTROL SYNCHRONIZING

The remote should already be paired from the factory, but if you need to synchronize the remote, follow the steps below:

1. Make sure BlueCube+ Media Player is powered ON (red LED).
2. Put the remote within 20 inches (0.5 meter) of the BlueCube+ Media Player.
3. Press and hold  MODE on remote control until the LCD shows “Pairing in Progress”. Release the button.
4. Within 2 seconds, the LCD will show “Paired”. If it fails to pair, the LCD will show “Retry again”. If this happens, wait 5 seconds and repeat steps above.

For any additional remote controls, you will also need to synchronize those remote controls to the BlueCube+ Media Player.

-  *If the pairing process is not successful, try again to put your remote close to the remote receiver or charge the remote control if the battery is low.*
-  *Depending on the frequency of usage, the remote may drain its battery. Please charge the remote before use. If the LCD shows nothing, the battery has been drained and will need charging.*
-  *If you have lost or damaged your remote control and buy a new remote control, follow the above steps to pair the new remote control.*

FUSION AIR SOUND SYSTEM (IF EQUIPPED)

EXPLANATION OF CONTROLS

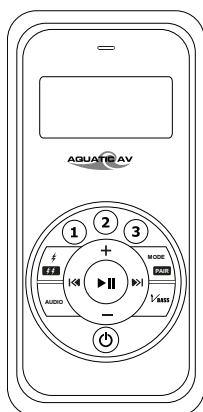

STEREO OUTPUTS

Internal stereo module has capabilities for Bluetooth, FM Radio, AUX and USB. There is no external capabilities for AUX and USB. For this reason, these inputs will not be applicable when seen on remote. Simply use Mode to rotate back to either Bluetooth input or FM.

REMOTE CONTROL

| BUTTONS | | BLUETOOTH | FM RADIO MODE |
|--------------|--|---|--|
| Power | | Press once: Toggle from Operation mode to Standby mode or vice-versa. Press and hold: No function. | |
| Mode/Pair | | Press once: Change mode. Press and hold: Synchronize remote control. | |
| Volume Up | | Press once: Volume up Press and hold: Fast volume up | |
| Volume Down | | Press once: Volume down Press and hold: Fast volume down | |
| Fast Forward | | Press once: Next track Press and hold: Fast forward | Press once: +0.05kHz Press and hold: Scan up |
| Fast Rewind | | Press once: Previous track Press and hold: Fast rewind | Press once: -0.05kHz Press and hold: Scan down |
| Play/Pause | | Press once: Play/Pause Press and hold: No function | Press once: Toggle mute Press and hold: No function |
| 1 | | Press once: No function Press and hold: No function | Press once: Listen to FM preset station 1 Press and hold: Set preset FM station 1 |
| 2 | | Press once: No function Press and hold: No function | Press once: Listen to FM preset station 2 Press and hold: Set preset FM station 2 |
| 3 | | Press once: No function Press and hold: No function | Press once: Listen to FM preset station 3 Press and hold: Set preset FM station 3 |
| EXT Trigger | | Press once: No function Press and hold: No function | Press once: No function Press and hold: No function |
| Audio | | Press once: Enter Audio Menu Press and hold: Save & Exit Audio Menu | |
| VBass | | Press once: Toggle VBass on/off Press and hold: No function | |





FUSION AIR SOUND SYSTEM (IF EQUIPPED)

LISTENING TO DEVICES

PAIR WITH BLUETOOTH DEVICE

1. Switch on your Bluetooth device.
2. Select 'AQUATIC AV' from the list of available devices to pair (no password is needed).





LISTENING VIA BLUETOOTH DEVICE

1. Bluetooth mode will be activated once a Bluetooth device is paired in any mode. Use  (MODE) to change to the Bluetooth mode to listen to music.
2. Play the song from device and the sound will play through the BlueCube+ Media Player.
3. Press  (PLAY/PAUSE) to play/pause the song.
4. Press  (FAST REWIND/FAST FORWARD) buttons to play previous/next song file.
5. Press and hold  (FAST REWIND/FAST FORWARD) buttons to fast forward / fast rewind the song file.
6. Previous/next track and volume up/down can be controlled directly from your Bluetooth device or directly from the BlueCube+ Media Player remote control.

BLUETOOTH MULTI-LINK

A second Bluetooth device can pair to the BlueCube+ Media Player even when it has been paired to another Bluetooth device. The second Bluetooth device will be able to play once the first device has stopped playing.



ADJUST VOLUME LEVEL

1. Press  (VOLUME UP) once to increase the volume.
2. Press  (VOLUME DOWN) once to reduce the volume.
3. Press and hold either  or  (VOLUME UP or VOLUME DOWN) to increase or decrease audio volume continuously.

FUSION AIR SOUND SYSTEM (IF EQUIPPED)

LISTENING TO DEVICES



ENTER FM RADIO MODE

1. Press  (MODE) on the remote control to switch to FM radio mode.
2. Press  (PLAY/PAUSE) to mute or unmute the audio.



 *If this is the first time you listen to FM radio, the default frequency will be 87.5MHz, as shown on the remote LCD.*

 *FM radio is only available when you are in FM Radio mode. Scan or seek FM radio Channels.*



SCAN OR SEEK FM RADIO CHANNELS

1. Press  (FAST REWIND/FAST FORWARD) to seek another station.
2. Press once  (FAST REWIND/FAST FORWARD) to -0.05kHz or +0.05kHz to the frequency.





SAVING RADIO CHANNEL TO MEMORY

To save the current frequency to memory, press and hold the ,  or  for more than 2 seconds. The station will be stored into relevant button.

LISTENING TO SAVED RADIO MEMORY

Press the ,  or  preset button once to listen to the station stored in that button.

ADJUST VOLUME LEVEL

1. Press  (VOLUME UP) once to increase the volume.
2. Press  (VOLUME DOWN) once to reduce the volume.
3. Press and hold either  or  (VOLUME UP or VOLUME DOWN) to increase or decrease audio volume continuously.

FUSION AIR SOUND SYSTEM (IF EQUIPPED)

ADDITIONAL FEATURES

AUDIO MENU

The BlueCube+ Media Player is equipped with an audio DSP (Digital Signal Processor) to provide preset listening experiences for different music types.

1. To enter audio menu, press **AUDIO** (AUDIO) button once on the remote control.
2. Each press of **AUDIO** (AUDIO) button will advance to the next audio setting as described on the right.
3. In the audio menu, press and hold **AUDIO** (AUDIO) to save and exit the audio menu back to the original mode.

If you have chosen preset equalizer (Rock, Classic, or Pop), the previous Bass & Treble settings will be overridden.

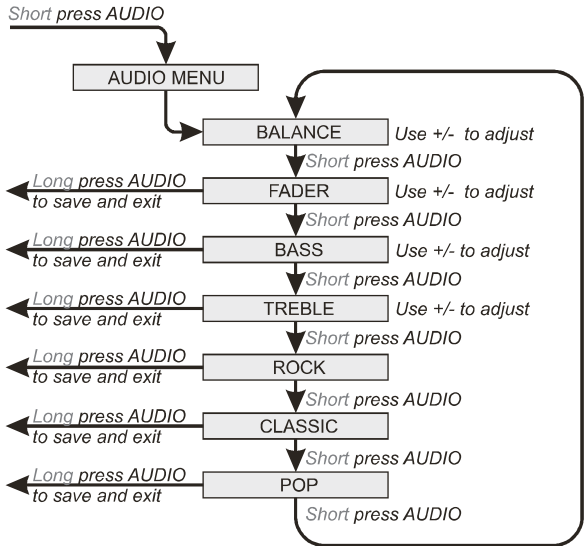

VIRTUAL BASS (VBASS)

Virtual Bass (VBass) boosts the bass of the audio signal using the latest DSP technology and is particularly useful when used with very small speakers to create perceived bass frequencies of a much larger speaker.

Press **VBASS** (VBASS) once on the remote control to toggle it on or off.

DREAM LIGHTING (IF EQUIPPED)

The optional Dream Lighting package adds beautiful soft streams of light to accent the exterior corners of your hot tub at night.

This feature utilizes a light sensor to turn on as daylight diminishes (dusk) and remains on through the night. You can manually shut off the lights by pressing the power button located on the light sensor, found on the skirting panel that's on the same side as the control panel of your spa. The Dream Lighting feature is only activated by darkness. It will not turn on during daylight hours or in well lit areas.

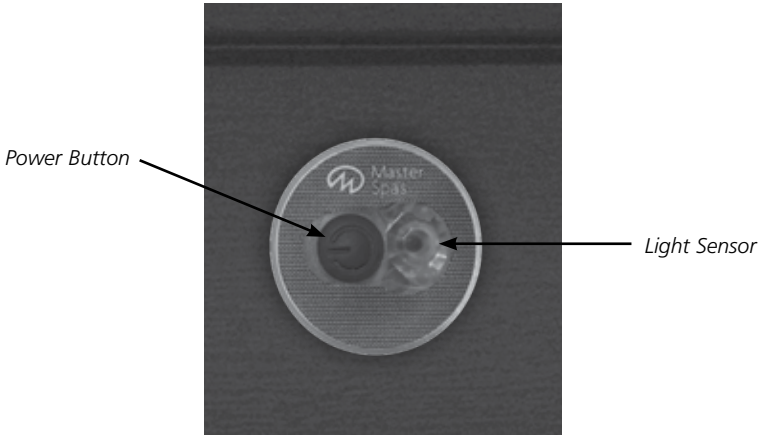

INTERNATIONAL LIMITED WARRANTY

CLARITY SPAS



 BY MASTER SPAS

NOTE: This International Limited Warranty applies to residential use outside of the United States and Canada.

3 YEARS - SPA STRUCTURE

Master Spas warrants to the original retail purchaser the structural integrity of the spa against water loss from the spa due to defects in material or workmanship, in the spa structure for a period of 3 years from the date of the original retail purchase. Master Spas will either repair, including the parts and labor to repair the spa structure, or replace the nonconforming Spa Structure. In the event of replacement, the cost of labor and equipment for removal and replacement of the unit is the sole responsibility of the Purchaser.

3 YEARS - SHELL SURFACE

Master Spas warrants to the original retail purchaser that the acrylic finish will not blister, crack or delaminate for a period of 3 years from the date of original retail purchase as a result of defects in material or workmanship. Master Spas will either repair, including the parts and labor to repair the shell surface, or replace the nonconforming shell. In the event of replacement, the cost of labor and equipment for removal and replacement of the unit is the sole responsibility of the Purchaser. There is no Shell Surface Warranty on blemished units.

2 YEARS - EQUIPMENT

Master Spas warrants to the original retail purchaser the spa equipment (pumps, heater and control system) should a component of the Equipment Pack fail or malfunction due to defects in material and workmanship, for a period of 2 years from the date of the original retail purchase. Master Spas will either repair or replace the applicable component, including replacement parts and labor to install them (parts and labor).

2 YEARS - PLUMBING

Master Spas warrants to the original retail purchaser for a period of 2 years from the date of original retail purchase that the plumbing of the spa will not leak due to defects in material and workmanship (Master Spas will provide replacement parts and labor to repair or replace the applicable components).

2 YEARS - JETS

Jet internals are warranted against malfunctions due to defects in material for a period of 2 years from the date of original retail purchase (Master Spas will provide replacement jet internal parts only). The cost of shipping and installation of any jet internals is the sole responsibility of the purchaser. After initial delivery and startup, discoloring or fading of the plastics, corrosion of any stainless steel components and sticking/seizing of the adjustable jet internals or their spinning nozzles are specifically excluded from these warranty terms.

5 YEARS/LIFETIME - SKIRTING* (MasterTech™ & DreamStone™ / DuraMaster Polymer™)

Master Spas warrants to the original retail purchaser that the optional MasterTech™ and DreamStone™ skirting will not crack or rip due to defects in material for a period of 5 years from the date of the original retail purchase. Master Spas warrants to the original retail purchaser only that the DuraMaster Polymer™ skirting will not crack or rip for the life of the spa. Bowing that can occur under some conditions is considered normal and excluded by this limited warranty. Normal wear and weathering that occur overtime are not defects. If the skirting on the spa fails due to defects in materials or workmanship, Master Spas will replace the applicable skirting components (parts only). The cost of shipping and installation of any replacement skirting is the sole responsibility of purchaser.

*If equipped. Options vary by model.

INTERNATIONAL LIMITED WARRANTY

CLARITY SPAS



 BY MASTER SPAS

NOTE: This International Limited Warranty applies to residential use outside of the United States and Canada.

1 YEAR - LED LIGHT SYSTEM*

Master Spas warrants to the original retail purchaser, for a period of 1 year from the date of original retail purchase that the optional, factory installed LED light system will not malfunction due to defects in workmanship and materials (parts and labor). If the LED light system or any component thereof fails due to defects in material or workmanship, Master Spas will either repair or replace the applicable components.

1 YEAR - DREAM LIGHTING*

Master Spas warrants to the original retail purchaser, for a period of 1 year from the date of original retail purchase, that the optional, factory installed Dream Lighting system in the spa skirt will not malfunction due to defects in workmanship and materials. If the Dream Lighting system or any of its components thereof has malfunctioned due to defects in workmanship or materials, Master Spas will either repair or replace the applicable components of the Dream Lighting system (parts and labor).

1 YEAR - OZONATOR*

Master Spas warrants to the original retail purchaser that the factory installed ozonator will not malfunction due to defects in materials or workmanship for a period of 1 year from the date of original retail purchase. If the ozonator malfunctions due to a defect in materials or workmanship, Master Spas will either repair or replace the applicable components including parts and labor.

1 YEAR - AUDIO EQUIPMENT*

Master Spas warrants to the original retail purchaser, the optional stereo and enclosure components within the audio system against malfunctions due to defects in material and workmanship for a period of 1 year (parts). This limited warranty on all optional Audio Equipment covers labor for a period of 1 year from the date of original retail purchase. After 1 year, the purchaser is solely responsible for any labor costs associated with the repair or replacement of any applicable audio components. Master Spas shall not be responsible for any damages or losses to any accessories (not supplied by Master Spas), including but not limited to iPods or similar systems, caused by a defect or malfunction of any Master Spas supplied component.

*If equipped. Options vary by model.

INTERNATIONAL LIMITED WARRANTY

EXCLUSIONS AND LIMITATIONS

EXCLUSIONS

This limited warranty is enforceable only by the original retail purchaser from the date of original retail purchase but is voidable if the entire purchase price has not been paid to retail dealer. Light bulbs, light lenses, fuses, covers, spa pillows or any dealer installed accessories are specifically excluded from this limited warranty. All warranties are void if the spa is placed in commercial service. Normal wear and weathering of finishes and components are not defects and specifically excluded from this limited warranty. In the event it is necessary to remove the spa from the residential premises to repair or replace any warrantable item, any and all cost of spa removal and replacement including but not limited to removal of the original spa and transportation of the replacement spa, damages to landscaping, decking, fencing or other structural alteration, or any cost related to obtaining access to the spa are the sole responsibility of the purchaser. Spa covers are not included or covered by this spa warranty. Freight/shipping costs for any warrantable replacement item is the sole responsibility of the purchaser.

LIMITATIONS

This limited warranty is voidable if the spa has been subject to misuse, alteration or attempted alteration, repairs or attempted repairs by a non-approved service center or if a failure or malfunction is due to improper installation, improper water chemistry, improper maintenance or lack of normal maintenance as prescribed in the Master Spas Owner's Manual, an act of God, weather conditions, animals, rodents, pests or any damage from causes beyond the control of Master Spas. Misuse or abuse shall mean operation of the spa other than in conformity with the Master Spas Owner's Manual. Such misuse and abuse shall include but not be limited to the following:

- Damage of the spa surface and components caused by leaving the spa uncovered or due to covering the spa with plastic film of any kind.
- Damage to the spa surface and components caused by use of a non-insulating cover or an unapproved cover not manufactured by Master Spas when the spa is subject to weather conditions and sun.
- Damage to the spa surface and components caused by contact with unapproved cleaners or solvents.
- Damage caused by operation of the spa at water temperatures outside the range of 34° F - 104° F.
- Freeze damage.
- Damage caused by unapproved sanitizers such as calcium hypochlorite, sodium hydroxide, "tri-chlor" type chlorines or any sanitizing chemical that may remain undissolved on the spa surface.
- Damages or malfunction due to a dirty, clogged, calcified filters or use of an unapproved filter cartridge.
- Damages or malfunction caused by failure to provide even, proper support for the spa.
- Damages or malfunction caused during installation of the spa.

INTERNATIONAL LIMITED WARRANTY

EXCLUSIONS AND LIMITATIONS

WARRANTY REGISTRATION AND WARRANTY CLAIM PROCEDURE

The original retail purchaser should register their spa purchase within 10 days from the date of original retail purchase to establish proof of purchase with Master Spas. Failure to register does not void this limited warranty but, upon any warranty claim, proof of purchase must first be provided to confirm original retail purchase date to the original retail purchaser. Spa Registration can be submitted online at www.masterspas.com/resources. In the event of a warranty claim of a defect or malfunction covered under the provisions of this limited warranty, the original retail purchaser must first notify in writing the retail dealer who sold the spa within ten (10) days of the initial malfunction or discovery of defect. If the retail dealer does not provide service, then the purchaser should contact Master Spas customer service department, via the web site, or provide written notice of the malfunction or defect at the address below. Upon notice of the warranty claim, the retail dealer or an approved independent service center representative will arrange inspection of the spa with the retail purchaser to determine if the claimed malfunction or defect is a covered malfunction or defect under this limited warranty. If it is determined that the malfunction is not covered by this limited warranty, the cost of the service call is the sole responsibility of the purchaser. If it is determined that the malfunction or defect is covered under this limited warranty, Master Spas through the retail dealer, or approved independent service center will repair or replace the covered item. In the event of spa replacement, the replacement spa will carry the balance of the original spa warranty from the original retail purchase date. Master Spas reserves the right for its dealers or approved service centers to collect from the retail purchaser reasonable travel expenses. In addition, access charges will be assessed if the spa is not reasonably accessible for inspection, repair or replacement. This limited warranty is extended only to the original retail purchaser and is not transferable. This limited warranty becomes void upon the transfer of ownership of the spa or moving of the spa to a different location.

DISCLAIMERS

MASTER SPAS LLC, NEITHER ASSUMES NOR DO WE AUTHORIZE ANY OTHER PERSON TO ASSUME FOR US, ANY OTHER LIABILITY IN CONNECTION WITH THE SALE OF SPAS MANUFACTURED BY MASTER SPAS. THIS LIMITED WARRANTY SHALL BE THE EXCLUSIVE REMEDY AVAILABLE TO A PURCHASER AND MASTER SPAS SHALL NOT BE LIABLE FOR ANY INCIDENTAL OR CONSEQUENTIAL DAMAGES RESULTING FROM MISUSE OF THE SPA OR CAUSED BY ANY DEFECT, FAILURE OR MALFUNCTION OF THE SPA, WHETHER A CLAIM IS BASED UPON WARRANTY, CONTRACT, NEGLIGENCE OR OTHERWISE. SOME STATES DO NOT ALLOW THE EXCLUSION OF INCIDENTAL OR CONSEQUENTIAL DAMAGES, SO THIS LIMITATION MAY NOT APPLY TO YOU.

TO THE EXTENT PERMITTED BY APPLICABLE LAW, THIS LIMITED WARRANTY SPECIFICALLY EXCLUDES ANY AND ALL IMPLIED WARRANTIES OF MERCHANTABILITY AND/OR FITNESS FOR A PARTICULAR PURPOSE, OTHERWISE ALL IMPLIED WARRANTIES ARE LIMITED IN DURATION TO TWO (2) YEARS FROM THE ORIGINAL DATE OF RETAIL PURCHASE. SOME JURISDICTIONS DO NOT ALLOW THE LIMITATION OF THE DURATION OF IMPLIED WARRANTIES, SO THIS LIMITATION MAY NOT APPLY TO YOU. THERE ARE NO OTHER WARRANTIES, EITHER EXPRESSED OR IMPLIED, OF ANY KIND OR NATURE WHICH EXTEND BEYOND THE DESCRIPTION ON THE FACE HEREOF. SOME JURISDICTIONS DO NOT ALLOW THE LIMITATIONS OF REMEDIES SO THESE LIMITATIONS MAY NOT APPLY TO YOU.

IF YOUR SPA IS DESIGNATED BY MASTER SPAS AS A "BLEM" OR AS "BLEMISHED", THE SHELL SURFACE IS NOT WARRANTED AND THE SPA IS PURCHASED "AS IS" REGARDING ANY COSMETIC BLEMISHES.



SPA CARE AND MAINTENANCE RECORD

MAINTENANCE AVERAGE TIMETABLES

Below is a list of routine maintenance and the guidelines on how often they should be done. The frequency in which these actions should be performed may vary depending on bather load and how often you use your spa.

- Test GFCI - Before each use
- Clean Filter Cartridge - at least once a month
- Clean and Condition Spa Cover - twice a month
- Drain and Clean Spa - every 6 months

MAINTENANCE LOG

Use the following lines to document your spa care and maintenance.

| MAINTENANCE PERFORMED | DATE | DATE | DATE |
|------------------------------|-------------|-------------|-------------|
| | | | |
| | | | |
| | | | |
| | | | |
| | | | |
| | | | |
| | | | |
| | | | |
| | | | |
| | | | |
| | | | |
| | | | |
| | | | |
| | | | |
| | | | |
| | | | |
| | | | |
| | | | |
| | | | |
| | | | |
| | | | |

SPA CARE AND MAINTENANCE RECORD

MAINTENANCE PERFORMED

DATE

DATE

DATE

| | | | |
|--|--|--|--|
| | | | |
| | | | |
| | | | |
| | | | |
| | | | |
| | | | |
| | | | |
| | | | |
| | | | |
| | | | |
| | | | |
| | | | |
| | | | |
| | | | |
| | | | |
| | | | |
| | | | |
| | | | |
| | | | |
| | | | |
| | | | |
| | | | |
| | | | |
| | | | |
| | | | |
| | | | |
| | | | |
| | | | |
| | | | |
| | | | |
| | | | |
| | | | |
| | | | |
| | | | |
| | | | |
| | | | |
| | | | |
| | | | |
| | | | |
| | | | |
| | | | |
| | | | |
| | | | |
| | | | |



Stay Connected, Keep in Touch



@MasterSpas #masterspas



Customer Service: www.masterspas.com/resources

6927 Lincoln Parkway, Fort Wayne, IN 46804
800.860.7727 CustomerService@MasterSpas.com

INTERNATIONAL VERSION

Master Spas® reserves the right to change product specifications or features without notice. Master Spas is a manufacturer of spas and related products, and we stand behind every product we produce pursuant to those representations which are stated in our written limited warranty. Your dealer is an independent businessperson or company and not an employee or agent of Master Spas, LLC. We cannot and do not accept any responsibility or liability for any other representations, statements or contracts made by any dealer beyond the provisions of our written limited warranty. Master Spas, Clarity Spas, The Ultimate Relaxation Machine, Master Blaster, and EcoPur are registered trademarks of Master Spas, LLC. MasterTech, DreamStone, and DuraMaster are all trademarks of Master Spas, LLC. Patents: masterspas.com/patents